

**PREVIEW  
OF AUDIO  
FAIR** pages  
18-19

# TAPE

**RECORDING  
FORTNIGHTLY**

## EVERYONE'S GOING ELIZABETHAN

GOING FOR BRITAIN'S MOST POPULAR TAPE RECORDERS



### GOING FOR THE PRINCESS!

*Going for tremendous performance . . . terrific value . . . and getting both. 3 speeds, 7" spools, four hours' playing time. Facilities for mixing and superimposing.*

**PRINCESS 39** gns complete

It's happening everywhere. Suddenly everyone is seeing the sense of buying a British tape recorder. Finding that British electronics, British engineering have no equals in this world. And finding that nowhere else do electronics and precision engineering combine so effectively as in the Elizabethan range.

**MAJOR ANNOUNCEMENT COMING**

at the Audio Fair

Stand No. 18

Demonstration Room No. 348



### GOING FOR THE AVON!

*Today's most astonishing tape recorder value. A first-class machine with excellent recording quality and sound reproduction. With facilities for sound mixing and superimposing. With simple controls, elegant styling — and all at a record low price.*

**AVON 27** gns complete

## ELIZABETHAN TAPE RECORDERS

E.A.P. (TAPE RECORDERS) LTD., BRIDGE CLOSE, ROMFORD, ESSEX. Tel: Romford 62366/7

*FIRST AND FOREMOST IN THIS FIELD*

ALTERNATE  
WEDNESDAYS

**1/6**

6th April, 1960

# The Sign of Good Tape!



Wherever you see this poster you can be sure to buy Emitape — the World's finest recording tape, preferred by professionals and amateurs alike.

## Emitape

*... and remember —*  
the **B.B.C.** use Emitape  
**9** times out of **10!**

**"44"** Popular (Acetate)

**"88"** General Purpose

**"99"** Long Play giving  
50% increased  
playing time

**"100"** Double Play

EMI SALES & SERVICE LTD (Recording Materials Division) HAYES · MIDDLESEX · Tel: SOUthall 2468

New H.P. Regulations, but—

# STILL NO INTEREST CHARGES UP TO 18 MONTHS

on all orders over £30



## FREE ILLUSTRATED 72-PAGE CATALOGUE

the most detailed publication of its kind

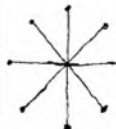

## HUGE STOCKS OF ALL MAKES

ensuring quick delivery to all parts of the country

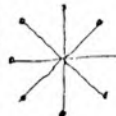

## HONEST, INFORMED ADVICE

from enthusiastic tape-recording and Hi-Fi specialists

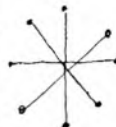

## COMPREHENSIVE MAINTENANCE SERVICE

and inexpensive maintenance contract if desired

### Tape Recorders

Grundig  
Elizabethan  
Ferrograph  
Vortexion  
Walter  
Brenell  
Reflectograph  
Simon  
Harting  
Telefunken  
Philips  
Spectone  
Verdik

Veritone  
Stuzzi-Magnette  
Fi-cord  
Truvox  
Kurland  
Reps  
Revox  
Wyndson  
Regentone  
Perth-Saja  
Elektron  
Minivox  
Korting

### Hi-Fi Equipment, Microphones, Speakers, etc.

Leak  
Quad  
Rogers  
Armstrong  
Jason  
Dulci  
Pamphonic  
Stentorian  
Avantic  
Pilot  
Collaro  
Elpico  
Decca

Philips  
Wright & Weaire  
G.E.C.  
Goodmans  
C.Q.  
Wharfedale  
Elac  
B.J.  
Garrard  
Connoisseur  
Goldring  
T.S.L.  
Stirling Tuners

### Tape

Emitape  
Scotch Boy  
BASF  
Grundig  
Telefunken  
Elpico  
Soundrite  
Gevaert  
Philips  
Agfa  
All Accessories.  
Tapes, etc. by  
return of post.  
All makes in stock.

You can choose with confidence from the leading Specialists:

## THE TAPE RECORDER CENTRE

For free Catalogue send this coupon to: The Tape Recorder Centre Ltd.,  
Dept. T, 75 Grand Parade, Green Lanes, Harringay, London, N.4.

STAmford Hill 1146

NAME ..... ADDRESS .....

(BLOCK LETTERS PLEASE)



# 5 reasons for choosing irish tape

The exclusive Ferro-sheen process produces a mirror-smooth tape and offers five distinct advantages:

1. Exceptional high frequency response, due to intimacy of contact between tape and heads.
2. Minimum head wear.
3. Freedom from head contamination by oxide build-up.
4. Considerable reduction in background noise.
5. Minimum drop-outs.

In addition, the Tensitized Mylar base gives Irish double-play tape twice the strength of conventional thin tapes.

Irish tape has only recently been introduced into this country, and supplies are not yet sufficient for it to be stocked by all dealers. If your local dealer does not yet stock Irish tape, give him this coupon, which will ensure that the spools you require will be sent him by return.



## \* PRIORITY ORDER

Please obtain for me the following IRISH tape

Brown Band	5"	5½"	7"	} Delete items not required.
Long Play	5"	5½"	7"	
Double Play	5"	5½"	7"	

NAME.....

ADDRESS.....

Note to Dealer: Send your order to us and we will dispatch the tape by return.  
WILMEX LTD., 131 Sloane Street, London, S.W.1.

Sole British Concessionaires:  
**WILMEX LTD.,**  
131 Sloane Street, London, S.W.1.  
Telephone: SLOane 0621

## TIP OF THE MONTH by Mr. Irish

Before connecting a lead from the radio to your amplifier or tape recorder, make sure that the radio is not a universal AC/DC set. With such radios the chassis is often "live" and thus, when plugging into an earthed device, one can receive an unpleasant, if not dangerous, electric shock. If in doubt consult your dealer.



### Brown Band (Acetate base)

600'	5" spool	17/-
850'	5½" spool	23/-
1,200'	7" spool	27/6



### Long Play\* (Mylar base)

900'	5" spool	28/-
1,150'	5½" spool	35/-
1,800'	7" spool	50/-



### Double Play\* (Tensitized Mylar base)

1,200'	5" spool	45/-
1,650'	5½" spool	52/6
2,400'	7" spool	80/-

\* Ferro-sheen process

What everyone wants to know . . .

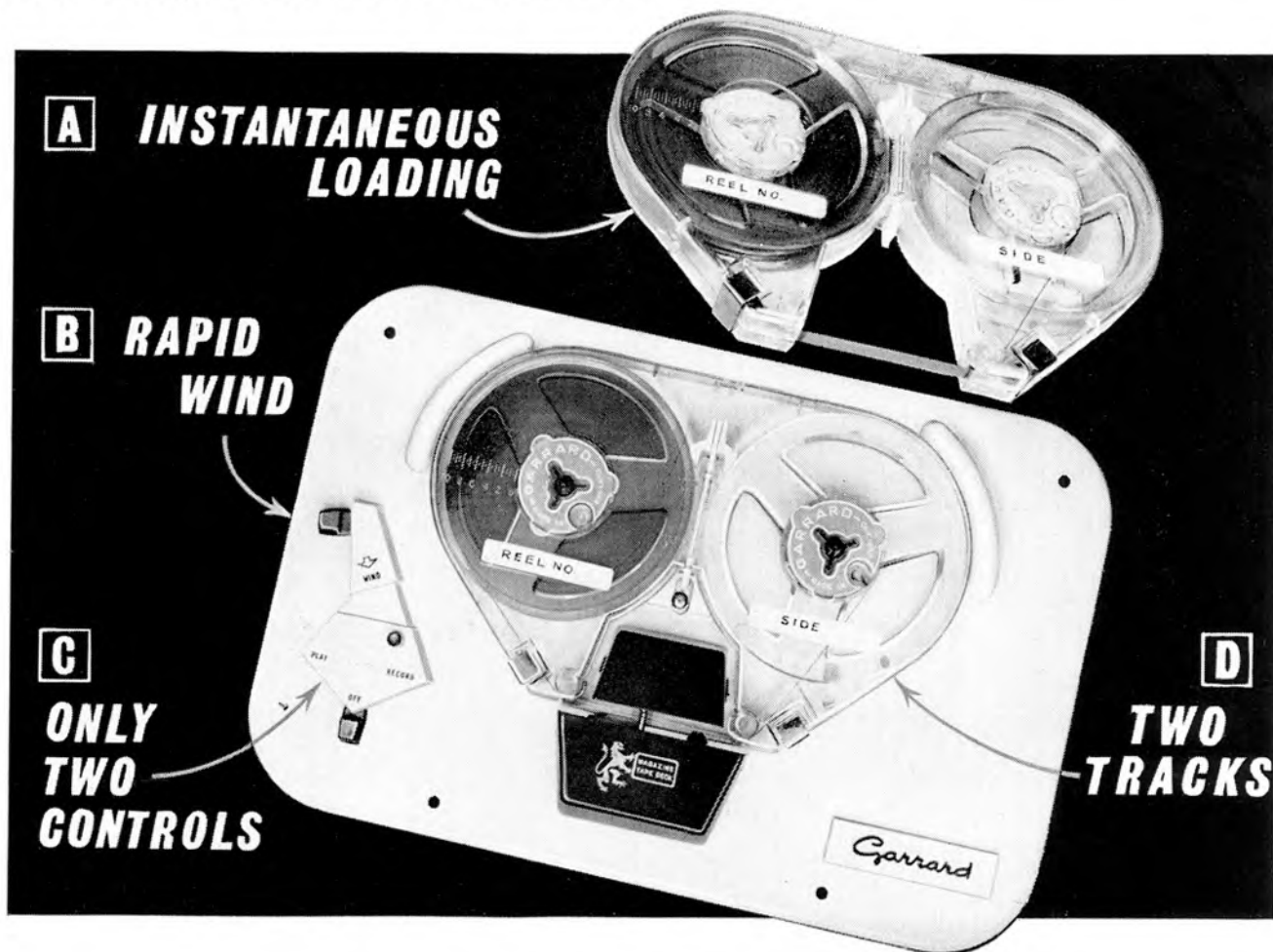

. . . about the **NEW**

- A INSTANTANEOUS LOADING**  
Magazine loads on to deck as simply as putting on a record,
- B RAPID WIND**  
Provision for rapid wind and tape location.
- C ONLY 2 CONTROLS**  
One for record and play.  
One for wind.
- D TWO TRACKS**  
Continuous play is always available with the Garrard loading method using two tracks.

# Garrard

## MAGAZINE TAPE DECK

### EASE OF OPERATION

Controls reduced to absolute minimum. Magazine eliminate tape threading, spilling and locating.

### PRECISION CONTROL OF TAPE TRAVEL

Garrard design achieves a new high level of precision engineering to ensure accurate control.

*The Machine for everyone*

Write for leaflet

“What everyone wants to know”



**GARRARD ENGINEERING AND MANUFACTURING CO., LTD.**

Factory and Registered Office : NEWCASTLE STREET, SWINDON, WILTSHIRE

Telephone : SWINDON 5381 (5 lines)

Telex 44-271



## BRITISH-MADE MICROPHONES

consistently specified for  
quality and reliability

MODELS FOR TAPE RECORDERS, STUDIO  
USE AND SPECIALISED APPLICATIONS

See the complete range at the  
**AUDIO FAIR, BOOTH 24**

or send for literature to

**LUSTRAPHONE LTD.** ST. GEORGE'S WORKS,  
REGENTS PARK ROAD, LONDON, N.W.1  
PR1mrose 8844

# FRANCIS OF STREATHAM

● *The Centre for Prompt Personal Attention and respect for your Pocket*

## NO EXTRA FOR CREDIT

No interest or charges on H.P. up to 18 months  
FREE SERVICE WHILST UNDER GUARANTEE

### HIRE SERVICE

Tape Recorders available on hire from 45/- per week

### MICROPHONES AND MIXERS

	£	s.	d.
Lustraphone LD/66 New Dynamic	4	2	6
Lustraphone "Lustrette" M/C	3	7	6
Lustraphone VR/64 Ribbon	7	17	6
Lustraphone LFV/59 Dynamic	8	18	6
Simon "Cadenza" Dynamic	10	10	0
Simon "Cadenza" Crystal	3	13	6
Reslo Ribbon	8	15	0
TSL 3-Channel Mixer	2	2	0
Grundig Mixer	16	16	0

Also by Ronette, Acos, etc. We will gladly advise on the type best suited to your requirements

### HI-FI AND ASSOCIATED EQUIPMENT

	£	s.	d.		£	s.	d.
Rogers Junior FM Tuner	24	13	5	Quad II Control Unit	25	0	0
Armstrong ST.3	26	gns.		Collaro 4T200	18	13	0
Dulci AM, FM	23	15	8	Lenco GL 58	less		
Jason FM	22	15	8	cartridge	19	17	6
Jason JTV/2	25	7	3	Jason J2-10, MKIII	37	10	0
Jason "Monitor"	19	16	3	Leak Stereo 20	30	9	0
Decca ffs Stereo P.U.	20	19	5	Tannoy Cartridges			
Garrard 301, strob.	23	18	4	Loudspeakers by—			
Garrard 4HF...	18	9	9	Expert, C.Q., W.B., Pye,			
Quad Amplifier	22	10	0	Goodman's, Wharfedale, etc.			

TAPE TO DISC AND TAPE COPY SERVICE

## PSYCHO-TAPES

Home Psychology for  
Tape Recorder Owners

PERSONALISED tapes recorded individually for each patient by well-known Psychotherapist for:—

**NERVOUS FEARS, STAMMERING,  
INFERIORITY, AND ALL PERSONAL  
PSYCHOLOGICAL PROBLEMS**

Also SPECIAL TAPES on:—

**DEVELOPING A POSITIVE PER-  
SONALITY, SELF-HYPNOSIS, MIND  
MANAGEMENT, HOW TO OVER-  
COME INSOMNIA, ETC.**

Please post Coupon NOW for full details

Please send free details of PSYCHO-TAPES

Name (Mr. Mrs. Miss).....  
(Block letters please)

Address.....

To THE PSYCHO-TAPE INSTITUTE (Dept. THI)  
27, YORK ROAD, ILFORD, Essex

- ★ COMPLETE T.R. SPECIALISTS
- ★ LARGEST SELECTION OF LATEST MODELS
- ★ NEW HI-FI DEPT. NOW OPEN

*Brenell Mk. V...	64 gns.	*Reflectograph 500	94 gns.
Brenell 3 Star	58 gns.	*Saba	79 gns.
*Brenell 3 Star Stereo	89 gns.	*Simon SP4	95 gns.
Elizabethan Avon	27 gns.	Simon Minstrelle	39 gns.
Elizabethan "Princess"	39 gns.	Spectone 161	49 gns.
Elizabethan Major	65 gns.	*Telefunken 76 4 Track	64 gns.
Elpico TR.400	26 gns.	*Telefunken KL85	75 gns.
*Ferroglyph 4AN	81 gns.	*Telefunken 85K	79 gns.
*Ferroglyph 4AN H	86 gns.	*Telefunken 75 15	54 gns.
*Ferroglyph 4AN S	88 gns.	Uher Universal	79 gns.
*Ferroglyph 808	105 gns.	*Uher 4 Track Stereo	102 gns.
Fidelity Argyll	29 gns.	*Vortexion WVA	£93 13 0
*Grundig TK60 Stereo	128 gns.	*Vortexion WVB	£110 3 0
Grundig TK20	52 gns.	Walter 505	57 gns.
*Grundig TK25	62 gns.	Wyndor Victor	45 gns.
*Grundig TK30	72 gns.		
*Grundig TK35	82 gns.		
*Harting 4 Track Stereo	86 gns.		
H.M.V.	£50 0 0		
*Korting 4 Track Stereo	68 gns.		
Magnafon	49 gns.		
Philips 4 Track	37 gns.		
Philips 4 Track	59 gns.		
Philips 4 Track Stereo	92 gns.		
*Reflectograph			
A-1/2 Track	95 gns.		
B-1/2 Track	95 gns.		

\*Microphone extra

### BATTERY OPERATED TRANSISTOR RECORDERS

Grundig "Cub"	26 gns.
Clarion	25 gns.
Minivox	37 gns.
Fi-Cord	59 gns.
Stuzzi "Magnetite"	69 gns.
Steelman	55 gns.

ALWAYS AVAILABLE Pre-Recorded Tapes by Saga and "Music on Tape," etc.  
ALSO Tapes of every size and type by leading makers ready for prompt dispatch.

**169-171 STREATHAM HIGH ROAD, LONDON, S.W.16**

**Hi-Fi Dept. 181 STREATHAM HIGH ROAD, S.W.16**

Between St. Leonard's Church  
and Streatham Station

STReatham 0466/0192

‘A new standard of quality by which other machines will be judged’

Angus McKenzie in **TAPE RECORDING AND HI-FI MAGAZINE**



\* Automatic, in the Simon sense, is meant to be taken literally: it means continuous replay—the machine stops, reverses and changes to the other track with only a two-second pause, and *with no necessity to touch any control*. Similarly, up to three hours continuous recording can be made without attention, the machine automatically stopping at the end of the second track.

This is the enthusiastic opinion of an expert, an independent reviewer, after thoroughly testing the Simon S.P.4. Throughout the Hi-Fi world, this superb new tape recorder, with its combination of high performance and range of exclusive features, is sparking off similar praise from those who have seen and heard it. Look at this list of star features—then come and see it for yourself at your nearest dealer—try it, hear it and you too will join the crowds of Simon enthusiasts.

★

**SIMON AUTOMATIC DECK** fully ‘push-button controlled’  
**AUTOMATIC TAPE REVERSAL** without touching controls  
**3-WAY MIXING FACILITIES** on both record and playback  
**BASS AND TREBLE LIFT AND CUT** with independent controls  
**REMOTE CONTROL FACILITIES** on both record and playback  
**HIGH QUALITY MONITORING** Paired bass and treble loudspeaker units  
**10 WATTS OUTPUT** from ultra-linear push-pull amplifier  
**PUSH-PULL OSCILLATOR** for noise and hum suppression  
**ACCIDENTAL ERASURE PREVENTION** by special record ‘safety button’  
**ACCURATE TAPE POSITION INDICATOR** based on linear tape scale  
**‘PIN POINT’ MODULATION** with cathode ray magic eye

# simon SP.4

incorporating the new Simon fully automatic deck

and you can replay stereos too

with the **SIMON STEREO ADAPTOR**

You can convert the SP4 for stereo at any time—and enjoy the brilliant realism in reproduction which only SP4 performance plus stereo can give. The Simon Stereo Adaptor replays pre-recorded tapes to CCIR specification and has full tone control as in SP4. Complete with amplifier and bass and treble speakers matching these in the SP4, price 49 gns.

Your Simon Dealer would be pleased to arrange H.P. terms

**95 gns.**

*Choose Simon for Sound*

Write for leaflet (E11)

**SIMON SOUND SERVICE LTD.,**

46-50 George Street, Portman Square, London, W.1

## HIGH QUALITY TAPE RECORDER SPECIALISTS

OFFICIALLY APPOINTED  
AGENTS FOR:

- ★ FERROGRAPH
- ★ REFLECTOGRAPH
- ★ SIMON
- ★ GRUNDIG
- ★ REPS
- ★ BRENNELL
- ★ TANDBERG
- ★ VORTEXION

Amazing  
Stuzzi Magnette  
2 Speeds  
Fully Transistorised  
Complete **69 gns.**  
Deposit £7.9.0.  
12 instalments  
of £5.8.4



ALSO IN STOCK:

PHILIPS  
TELEFUNKEN  
VERDIK  
KORTING  
WYNDSOR  
SPECTONE 161  
MAGNAFON

REGENTONE  
SOUND  
FERGUSON  
BALMORAL  
SABA  
CLARION  
KURLAND

PERTH-SAJA  
ELEKTRON  
HARTING  
TRUVOX  
VERITONE  
FI-CORD  
ARGYLL

### On NO INTEREST TERMS

150 models on display — free maintenance — 2/- in the £ deposit  
free insurance on your instalments.

### Best PART EXCHANGE

ALLOWANCE ON YOUR OLD TAPE RECORDER HI-FI EQUIPMENT

REW EARLSFIELD Ltd. 545 Garratt Lane, S.W.18

Tel. Wim 0709

10 minutes bus from Tooting Broadway; 100 yards from Earlsfield Station

### The Saba Story

The Saba Tape Recorder is made at Villingen in the Black Forest. It is a two-speed— $7\frac{1}{2}$  and  $3\frac{3}{4}$  i.p.s., twin track, two way machine built to professional standards. When recording it reverses automatically and stops at the end of track II; when playing back it reverses until stopped. It takes 7 inch reels, giving over 4 hours playing time at  $3\frac{3}{4}$  i.p.s. The record-replay heads measure 0.00016 ins., which with careful attention to circuitry give frequency responses of 40 to 20,000 c.p.s. at  $7\frac{1}{2}$  and 40 to 16,000 at  $3\frac{3}{4}$  i.p.s., all  $\pm 3$ dB, at a signal-to-noise ratio better than -40 dB unweighted, including hum. This means that, at normal room volume, a recording of the average f.m. broadcast combined wow and flutter is less than can be detected even on sustained piano type motor is silent in operation, sounds the same at either speed. The Saba will fast wind 1,800 ft. in either direction in under 3 minutes. Braking is instantaneous, even on fast pentode output with triode driver without audible distortion into two elliptical speakers  $7 \times 4$  ins. There are separate inputs for low-impedance which may be left permanently connected; there is a knob to choose the one required. There are outputs to an external amplifier, to the output stage of a radio and to an external speaker. The internal speakers can monitor; there is an erase cut-out button. Clicks on the tape are attenuated. Control is entirely by relays, actuated by illuminated buttons; no pressure pads are used. The Saba which is housed in a two-tone brown case will give many years of that contentment born of the conviction that one has the best. It costs 79 guineas without microphone. Write for multi-coloured fully descriptive brochure to Dept. SS5, Selmer, 114 Charing Cross Road, London, W.C.2.







The man who knows what's inside says:

# You get more out of **TELEFUNKEN**

## **TELEFUNKEN Magnetophon 75K-15**

TWO TAPE SPEEDS  $3\frac{1}{2}$  ips and  $1\frac{1}{2}$  ips

FREQUENCY RANGE 60-16,000 cps at  
 $3\frac{1}{2}$  ips and 60-9,000 cps  
at  $1\frac{1}{2}$  ips

PLAYING TIME 6 hours 20 minutes  
( $5\frac{1}{4}$ " DP tape at slow speed)

Press button controls. Extra-sensitive braking and tape tension control system.

Recording head with ultra-fine gap. Indirect flywheel drive. Fast re-wind, quick stop button. Digital counter. Automatic tape-end stop. Connections for earphones, remote stop/start control and extension speaker. In attractive light-weight Styron Case.

PRICE: **52 GNS**  
(excluding microphone)

## **TELEFUNKEN Magnetophon 75T-15**

Table model with output stage only. PRICE: **45 GNS**  
(excluding microphone)

## **TELEFUNKEN Magnetophon 85KL**

Six watts push/pull power stage, two matched oval speakers with cut-out switch, volume control, and separate bass and treble tone controls.

Monitoring through loud-speaker or earphones while recording. Straight through amplifier facilities. Magic eye level control. External speaker connection. Continuously variable trick control can be fitted. In luxury case.



PRICE: **79 GNS**  
(excluding microphone)

and the amazing

## **TELEFUNKEN Magnetophon 76K**

Over 12 hours playing time from one  $5\frac{1}{4}$ " DP Tape—4 track selection and super-imposition facilities.

PRICE: **64 GNS**  
(excluding microphone)

*A full selection of Telefunken Accessories, Microphones and Telefunken tapes are available. Ask for free brochure.*

# **TELEFUNKEN**

*The originators of Tape Recording*

SEND COUPON for details of the complete range to:

**WELMEC CORPORATION LIMITED**

147-148 STRAND, LONDON, WC2

Name .....

Address..... TRG

# Listen Before You Leap



**T**HOSE of us who know little about decibels and flat frequency responses might not raise our eyebrows at the facts and figures describing the much-talked-about new WyndSOR "Victor" portable. Those who are genned up to translating the specification into words and music are not surprised that the "Victor" sounds better than some tape recorders nearly twice the price. But make no mistake if you are about to plunge: the WyndSOR "Victor" is a quality-all-the-way portable, so beautifully designed and executed as to bring professional-sounding recordings within the reach of the most non-technically-minded amongst us.

Mark these following features and ask yourself how does WyndSOR do it at the price.

- \* frequency responses:—
  - 7½ i.p.s.—50 to 15,000 c.p.s. better than ±3 dB.
  - 3½ i.p.s.—50 to 9,000 c.p.s. better than ±3 dB.
  - 1½ i.p.s.—50 to 5,000 c.p.s.
- \* full frequency equalisation *at all speeds*.
- \* 10" × 6" elliptical speaker in detachable lid.
- \* up to 8 hours playing time on one D.P. tape.
- \* monitoring through its own speaker with independent control.
- \* finger-tip controls closely grouped.
- \* mixing facilities for mic and gram/radio inputs.
- \* additional output with automatic speaker cut-out.
- \* facility for use as an amplifier.
- \* three independent 4-pole motors.
- \* unique styling in two-tone grey with gilt fittings.
- \* twin tracks \* pause control \* tone control.
- \* guarantee: 12 months (valves 90 days) and the name of WyndSOR.

And how *do* they do it? By experience that ten years' manufacture of quality tape-recording equipment only can bring. By design-creation only after intensive market research and nation-wide trade inquiries, so that WyndSOR tape-recorders virtually sell themselves, without sales-force, without large advertising campaigns, without exhibiting at you-know-where, and with minimum servicing requirements after sales. All these overheads are conspicuous in the price by their absence.

If history is anything to go by, widely publicising the "Victor" would overwhelm the WyndSOR factory. WyndSOR policy is never to sacrifice quality for quantity and the fact is that there were never enough of the "Victor's" predecessor, the "Viscount," to satisfy the demand. So now is the time for all good enthusiasts to inquire at WyndSOR dealers or to send postcards (clean variety still preferred) to the modestly proud makers for the names of nearest stockists. There is nothing more annoying than hearing a WyndSOR just after buying an ordinary tape recorder.

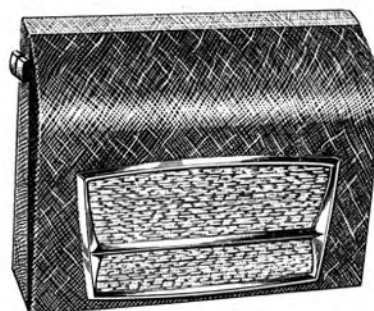

the WyndSOR "VICTOR" complete with crystal microphone, 1,200 feet of tape, and spare jackplug, is only 45 guineas.

## WYNDSOR RECORDING CO. LTD.

(Contractors to H.M. Government)

WyndSOR Works,  
2 Bellevue Road,  
Friern Barnet, London, N.11

Telephone: ENTerprise 2226/7  
Telegrams: Wyndreco, London



Tape Recording and Hi-Fi Magazine is published fortnightly, on alternate Wednesdays, by Print and Press Services Ltd., from 7 Tudor Street, London, E.C.4

EDITOR: R. D. BROWN
TECHNICAL ADVISORY EDITOR: CHARLES LANGTON, A.M.Brit.I.R.E., A.M.Inst.E.
MUSIC: EDWARD GREENFIELD The Guardian recorded music critic
DON WEDGE News Editor, New Musical Express
MOVIE-MAKING: JOHN ALDRED
NEWS AND CLUB ACTIVITIES: FRED CHANDLER
OVERSEAS CORRESPONDENTS:
FRANCE: GEORGE GINIAUX Revue du Son, 40, rue de Seine, Paris-6e
U.S.A.: PETER M. BARDACH 210-16, Grand Central Parkway, Queens Village 27, New York

The Editor is always glad to receive articles, news items, illustrations, etc., intended for publication and payment is made on the first of the month following publication. When not accepted, material will be returned if a stamped, addressed envelope is enclosed, but the Editor cannot accept responsibility for the safety of such material.

"Tape Recording and Hi-Fi Magazine" is available by a postal subscription at 45s. per annum, post free, or it can be obtained at newsagents, bookstalls and radio and music dealers. In the event of difficulty, write to the distributors, Rolls House Publishing Co., Breams Buildings, London, E.C.4.

Back numbers, if still in print, are available at 2s. 6d. per copy for issues up to November, 1959, and 2s. per copy for later numbers.

EDITORIAL

Address all communications
7 TUDOR STREET, LONDON, E.C.4
FLE 1455-6

ADVERTISING

All advertising communications to
1 CRANE COURT
FLEET STREET LONDON, E.C.4
FLE 0197

IN THIS ISSUE

We take the view . . . 12
The World of Tape 13
A news digest
Tape Records Reviewed 14
Edward Greenfield
Pioneers with a portable 14
G. F. Ashwell
Stereo notes 16
Douglas Gardner
Tape in the Church . . . 16
Stanley Jepson
. . . and in the Church Hall 17
R. J. Heathorn
Preview of the Audio Fair 18
The New Decks—7 20
Grundig TM60
A home-built battery recorder
—part 4 22
Richard A. Margoschis
Equipment under test 25
Sound effects 26
Alan Edward Beeby
New Products 27
News from the clubs 29

# We take the view . . .

## A DIGEST OF NEWS, COMMENT AND EDITORIAL OPINION

**M**Y Scottish correspondent has sent me details of a Paisley family which declares it has given up letter-writing. All their contacts with relatives and friends is done by tape. They think it is a splendid idea; they get more news of one another, and they can hear the children growing up, as the sound of their voices changes.

Well, well. It has set me thinking, and wondering if a day will dawn when the human race evolves beyond the written word. For this does not stop at letter-writing.

I see that a big firm of publishers, unable to get a manuscript out of Brendan Behan, the Irish dramatist, sent an executive over to Dublin with a recorder. Behan put eight hours of racy reminiscence on to tape. The idea was to secure sufficient material for a book—and it will, in fact, be published as a book.

But Behan is Behan. He did not simply talk. He recited poetry, he sang songs, he even brought the Behan cat into it. And so it has been decided that, as well as the book, there must be a long-play record.

Ah, ah, you say, but what about text-books? At East Ham Grammar School, I read, two of the lower forms are learning to speak French by animated cartoon film strips and tape recorders, without a text-book in sight.

What about storage of information in libraries? No, not even that calls for books. Information of every kind is stored in the new computers in the form of electrical impulses on tape.

The day may indeed come, it seems to me, when only a minority of "intellectuals" can read and write.

### News from Nigeria

**T**ONY GIBSON, one of the original members of the BBC "Sound" team and a judge of the first two British Tape Recording Contests, is doing splendid work as Controller of Staff Training with the Nigerian Broadcasting Corporation.

A copy of a recent staff training bulletin which has reached me from Lagos demonstrates what use he is making of tape. Special staff training tapes are issued every month, each of them a valuable magazine in sound. One of the latest issues contains a collection of

sound effects—50 seconds of waves, 40 seconds of traffic noises, 28 seconds of market crowds, then train noises, and so on.

Writers and producers are urged to build up a short feature around these effects, working out an imaginative script.

This is an idea that might appeal to clubs as a suitable competition for their members.

### Why the delay?

**I** HAVE felt for some time that some of the firms which market tape records ought to pursue a more aggressive marketing policy. But I had not realised the effect of present attitudes until I heard from a Cardiff solicitor of his experience in trying to buy stereo tape records made, and

advertised, by one of the biggest of the firms in the field.

On September 15 he ordered four tapes due for release on October 2. He received them late in November.

Just before Christmas he ordered more tapes, which had been released in September. I will not go into the almost incredible story of his efforts to get these tapes—in exchange for good money; suffice it to say that he is still waiting for them, and still working hard to stimulate the record firm into activity.

From the evidence sent me, the local retailer seems free from any responsibility in the matter; the blame lies on the record company.

Now there may be reasons for this, but what they are is irrelevant. In a matter of this kind, the customer is the important person. If he is given so poor an impression of what is being done to serve him, he simply will not buy.

Tape recording is not so firmly established that it can afford to alienate the enthusiasts. In any case, there are other firms outside this country which will quickly move in if our own manufacturers are half-hearted.





The world  
of tape

A NEWS  
ROUND-UP

A recorder in the  
council chamber

## TAPE KEEPS THE CLAN IN TOUCH

**D**AME FLORA MACLEOD, of Macleod, Chief of Clan MacLeod, is in hospital after an accident. In order that she may keep in touch with her clansfolk, the Clan MacLeod Society has presented her with a tape recorder.

This happy idea was unanimously approved at the annual meeting of the Society, when it was reported that, though she is making excellent progress, it will be a long time before her injury is successfully mended.

A special tape recording was made at the annual meeting by Mr. Alistair M. MacLeod and this was sent to Dame Flora in the Raigmore Hospital, Inverness.

## NEWS IN BRIEF

**S**COTS in the United States have been imagining themselves at last year's Scottish cup final as they listen to a tape made at the game by a Paisley man who was on a visit to his home town from America at the time. The tape has been well passed round.

\* \* \*

**L**EEDS Education Committee are shortly to supply primary schools in the city with tape recorders and sound equipment. Secondary schools have already been supplied.

\* \* \*

**S**TUDENTS studying languages at the I.B.M. training school have—apart from the usual teaching, book and visual aids—been supplied with recorders by the firm, so that they can polish up their accents at home.

*Eamonn Andrews presents an Avon tape recorder to Miss Sherry Neall, winner of a raffle organised to raise funds for the Sunshine Homes for Blind Babies. The raffle, part of the proceedings of Sportsman's Night, an annual gala at the Player's Theatre, London, arranged to help this worthy charity, raised well over £100. With Eamonn to present the recorder is the lovely girl featured in the Elizabethan adverts*

## New Look for Audio Hall

The 1960 Radio Show (Earls Court, August 23-September 3), will have a completely restyled Audio Hall.

In response to suggestions made by 1959 Exhibitors, the lay-out has been much improved to ensure that this section will readily be seen by every visitor, and that every stand will have an equal chance of being visited.

The present plan of the Audio Hall has eight stands grouped together in a central block, and the remaining 31 stands, separated from them by a wide gangway, in a single row along the perimeter of the hall.

Consideration is also being given to the possibility of including in the Hall some form of central feature which will be linked with the general interest in recorder music, etc.

## “TAKE IT OUT” SAID THE MAYOR

**A** COUNCILLOR who took a tape recorder into the council chamber at Salford, Lancashire, recently, found himself in trouble. The Mayor told him that, unless he removed it, he would have to go himself!

Councillor Gerald Joplin, one of the minority of Conservatives on the council, wanted to record council proceedings so that he could play them back from a touring van to the voters.

His purpose?

The Conservatives, he declared, had been subjected to abuse and interruption when putting their views to the council. The tape recording would have given the voters “a picture of Socialist dictatorship more vivid than they have ever had before.”

But Councillor Joplin announced to the council that he had the machine with him and the Mayor immediately told him: “You have no right to bring anything like that into the council without notice or permission. Please take it out.”

## BSRA home constructors' contest

**T**HE British Sound Recording Association has this year renamed its annual “Amateur Competition” the “Home Constructors Competition,” and it will include a section for work by non-members of the Association.

Entries are invited for this competition, which will be held at the Royal Society of Arts, London on Saturday, May 21.

There are two classes:—

Entries submitted by B.S.R.A. Members. In addition to the President's Trophy, there will be the *Wireless World* award of 10 guineas, and the Guy R. Fountain award of technical

books to the value of 10 guineas.

Entries submitted by non-members. The winner in this class will receive the *Hi-Fi News* award of 10 guineas.

Apparatus submitted for the Competition should be associated with the recording and reproduction of sound, including appropriate test equipment. Exhibits will be judged on the score of technical originality, suitability for purpose, design and finish.

Application forms may be obtained from the Association offices at “Greenways,” 40, Fairfield Way, Ewell, Surrey, and entries should be submitted not later than May 14.

---

## EDWARD GREENFIELD

(recorded music critic of *The Guardian*)

reviews the latest Tape Records

---

# A worthy product of a versatile genius

IT is not surprising that on both sides of the Atlantic *West Side Story* has become such a smash hit. On the face of it, it may seem the most squalid of adaptations of the "Romeo and Juliet" story, but behind the apparently sordid setting of down-town New York Leonard Bernstein has created something which evokes emotions far removed from squalid ones.

It is a worthy product of one of the most versatile geniuses to have appeared in the musical world this century.

Composer in two entirely separate (and generally opposed) musical fields, concert pianist, principal conductor of the New York Philharmonic Orchestra, organiser of spectacular festivals, Bernstein is a fabulous figure who—thank goodness—completely gives the lie to the depressing modern assumption that a man must concentrate on doing one thing well and only one.

Leaving aside all the brilliance of production and vigour of performance and judging *West Side Story* on its purely musical merits, I do admittedly have serious doubts.

For one thing I feel that Bernstein could have paid more attention to the quality of his melodies. *Tonight* is a magnificent melody, one that is at once memorable and well-shaped and interesting, but I do not feel that the rest of the melodic invention is up to that.

Often, in fact, where the score would gain from a recognisable tune, Bernstein seems deliberately to avoid sinking into something which might lead him into sentimentality. But surely in a musical it is better to run the risk of sentimentality with good tunes, rather than shirk the issue with snappy rhythms that never fail to sound sophisticated. I must confess, too, that apart from *Tonight* many of the confessed melodies sound undistinguished to my ears.

Not that I always demand distinction in a musical, but Bernstein, of all people, while he was about it, should have paid more attention to writing tunes that were both popular and good. *Tonight* itself shows that it can be done.

But these criticisms are only intended to show that *West Side Story* can stand criticism on a serious level musically. When produced and acted with the right verve, it becomes irresistible. The new stereo Saga tape has—instead of those in the production at Her Majesty's—Bruce Trent and Lucille Graham taking the leading parts.



Their voices are not, perhaps, quite in character. Bruce Trent is a little too mature (not old, mind) for a teenager hero and Lucille Graham has a little too sweet freshness about her voice which does not quite shake off the atmosphere of Grand Hotel. But it is a change to have the parts sung really musically and that, I rather think, on a recorded performance, is much more essential than completely exact vocal characterisation.

The remaining singers, Mary Thomas, Joyce Berry and Maureen Fulham, come, I understand, from the Her Majesty's cast, and fit in most convincingly. It was inevitable, of course, that some numbers would have to be omitted if the number of solo singers was to be kept down and the expense of hiring a chorus avoided.

This means that *When you're a jet, Gee, officer Krupke* and *America* have had to be omitted on this tape, but there are still ten of the numbers, as well as the Overture and Finale.

My one real complaint is that the orchestra, under the extraordinarily able direction of the regular conductor, Lawrence Leonard, does not really come up to the standard that American recordings of American musicals have made us expect. It shows how much more critical one is when listening to a record than when listening in the theatre, for this is, in fact, the orchestra which performs at Her Majesty's.

The stereo is very firm and bright. I am not sure that the strings are quite as smooth as they might be, but that is something which, for most people, will be a positive advantage in such wonderfully brash, rumbustious music.

"*West Side Story*": Stereo, 7½ ips. STE 3005. Monaural, 7½ ips. STB 8022; 3½ ips. STG 8022.

### B.B.C. "Sound" Programme

#### Sound and Film

Tristram Cary, John Aldred and Philip Jenkinson discuss ways in which sound recording enthusiasts can collaborate with amateur cine enthusiasts

3 p.m. Sunday, April 10, with a repeat at 6.40 p.m. Monday, April 18

IT IS TEN YEARS SINCE  
A LONDON TRIO, G. F.  
ASHWELL, J. LAW AND  
V. JONES, CAUSED THE  
CURIOUS TO STARE AT  
THE EQUIPMENT THEY  
SET UP IN A FAIR

### Mr. Ashwell tells the story

THE year was 1950. A strange apparatus was set up in the middle of the crowded fair-ground. It looked like a portable radio but in addition to the familiar controls, it had two reels revolving, feeding through a mysterious brown material. Connected to this box of tricks were two accumulators and a large, heavy box which produced a sound like an electric motor when switched on.

Three engrossed men were busy plugging in this, testing that, adding to the curiosity of the onlookers. Then there was the microphone, suggesting that the whole outfit was a radio transmitter—but where was the aerial, and what about those slowly revolving reels.

Everybody was puzzled. We were on location with something new—a tape recorder, plus accompanying equipment which would raise a smile today amongst recording enthusiasts.

We first considered the possibilities of recording in 1949 when, being interested in passenger transport as a hobby, we were seeking some means of preserving the sounds of the London trams before they were withdrawn in 1952. Jack Law had already built a disc recorder and got fair quality off microphone and radio, but the difficulties of making this portable complete with power pack—to say nothing of getting the gear on to the vehicle for recording purposes—were so great that we had to abandon that idea. Even thought up a scheme for recording via the telephone from the roadside!

It was not until the following year that the first type of Scophony-Baird recorder seemed to offer the solution, provided that it could be run independently of the main. We accomplished this by acquiring two sets of 12 v. 14 a.h. ex-Government accumulators and a rotary convertor. The latter was origi-

# Pioneers with a 'portable'

nally mounted in a heavy metal case; we built it into a lighter wooden box, with a compartment for microphone, cables, etc.

After a little trouble due to overheating, a fan was fitted, and inlet and outlet holes drilled for ventilation. Other difficulties were experienced with "microphonic" co-axial cable and pickup of hum from the convertor, but after various experiments these were eventually overcome. The set-up was completed in August, 1950 and is shown in the accompanying photograph.

Using the batteries shown and operating for brief periods, we were able to record for a total time of 15 minutes before the meter (fitted later) showed a drop in mains voltage. Whereas on true mains a voltage drop alone would not be of much importance, with a rotary convertor supply a drop in voltage is accompanied by a proportionate drop in frequency and, therefore, a quite serious slowing of the tape speed. Considering the small capacity of the batteries they stood up well to the 9 amp. drain but the much heavier current required for rewinding prohibited this "on location."

This tape recorder ran at one speed only—7½ ips, was single-track, and boasted no fast forward wind. The azimuth was not originally set to the now standard 90°, as we discovered when we later played our early tapes on other machines. The recording level indicator was simply a 6 v bulb which was designed to glow at full modulation (but which, with modern high coercitivity tapes, lights up the face of the operator without apparent overloading). Frequency response as measured originally was within the makers' specification, bearing in mind that no db tolerance was quoted!

In fact, various modifications to the circuit were desirable and were carried out with subsequent gain in approximately flat frequency response. A rather high hum level was reduced by improved smoothing and a mu-metal shroud between the heads.

Our early recordings were made using the moving coil microphone supplied, but we later progressed to a Gramplan and finally to the Weston "ball-and-biscuit" microphone shown in the illustration.

The whole equipment weighed nearly a hundredweight and needed a three-man team to carry it around—a contrast to the shoulder-slung portables of today!

Our first recording was of a London tram in August, 1950, and we subsequently attended all the tramcar "funerals," recording typical tramway sounds and interviewing, among others, an M.P. and two Mayors who were taking part in the "last car" ceremonies in their boroughs.

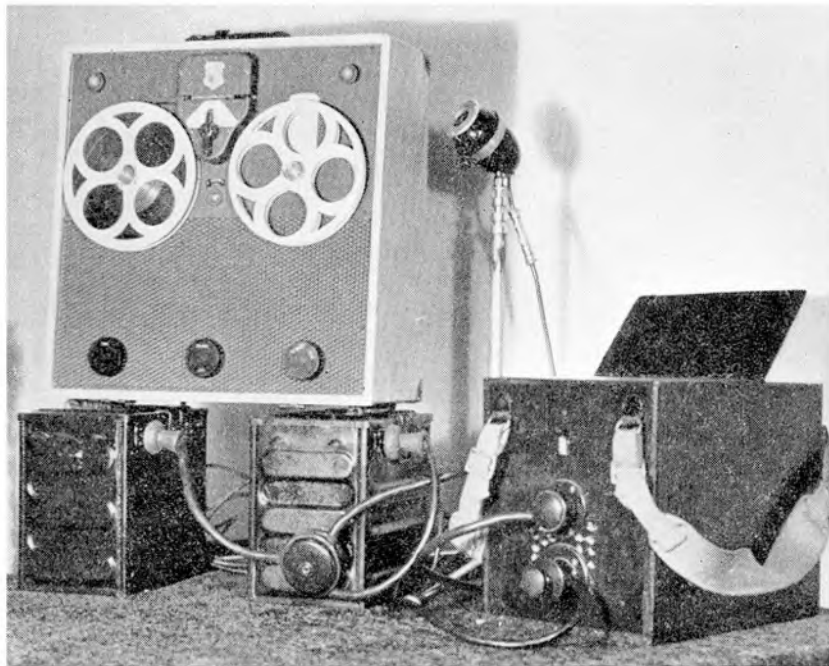

The equipment described in this article

From 1950 to 1952 we took the outfit to record buses, trains, trams, and river steamers, all on batteries. In this way we built up a library of recorded sound which now numbers over 40 items.

A rather amusing incident springs to mind in connection with an early attempt to capture the sounds of a fairground. Having set up our equipment, we were approached by a uniformed official who declared that "musical instruments" could not be operated without the permission of the local Council. As the legal status of a tape recorder seemed to be in doubt we duly applied for such permission. The Council had not got round to printing permits to operate such new-fangled contraptions, however, so we received instead a "Permit to Drill Troops," suitably amended, of course.

Soon after purchasing the recorder we were asked by an amateur dramatic society to record extracts from their latest production. This we did with but one microphone placed in the footlights. Dubbed discs were then made available to the members of the cast. This was in October, 1950.

The following year we conceived what we considered a bold idea of adding sound to several 9.5 mm. films we had made for a transport and travel society in which we were interested. We found that our recorded commentary kept in sync, by occasional slight adjustment of the projector speed control, but more recently a strobe wheel has been em-

ployed, using spilled light from the projector gate.

After two years of portable recording, it was found that the original accumulators were giving trouble—we had two sets—so we invested in two 80 a.h. car batteries, which we used in 1954 to record on-the-spot sounds for a more ambitious film on transport. As this film ran 45 minutes and was made before the advent of long-play tapes, we spent many hours of experimenting with larger reels, an extra motor to run the take-up spool, friction drives, braking devices, etc.—which gave all sorts of troubles. At one show almost the last 600 feet of tape had to be coaxed through by hand. Recently the whole sound track was remade on long-play tape.

The work on this film was really the last portable job we did with the recorder and soon afterwards the convertor was disposed of and the batteries sold for scrap.

The tape recorder is still in our possession but, as we feel that its days are numbered, we are shortly putting into hand the copying of all our tapes so that they can be played on standard two-track machines; as it is, the original recordings can only be satisfactorily reproduced on the Baird machine.

We believe we may have been the first in the amateur field to adapt a tape recorder for portable use, and we should like to hear of any similar attempts made in 1950 or earlier.

## STEREO

By D. W. Gardner

UNTIL the stage has been reached when everybody knows somebody with real stereo equipment, properly installed, potential buyers will remain disproportionately dependent on shop and show demonstrations—which are usually far from satisfactory from the point of view of convincing one of the true worth of stereophony.

This little problem is aggravated by the fact that most people assume that the boot is on the other foot. They calculate that, if anything, the demonstrator is in a position to rig the performance so that it sounds better than it would normally do in practice. Slight defects, or a failure to live up to high expectations, result in the deduction: "If they cannot get it right at a demonstration, what hope is there for me?"

Much could be done, I feel, by a big effort to improve the standard of demonstrations. We could begin by asking ourselves why so many of them fail. Undoubtedly a major cause is the unsuitability of the premises.

I suggest that, where possible, the problem of demonstrating stereo pure and simple should be separated from the matter of putting different pieces of equipment through their paces. A small room with just one installation—working perfectly—in the middle to high price range—would help listeners to settle the over-riding question of whether or not stereo is a good thing.

At the audio shows the demonstrators have to make the best of the rooms they have, and here the best chance of improvement lies in the choice of material. Spectacular stereo effects like trains and ping-pong have even more serious disadvantages, I believe, than the simple one that they tend to suggest that stereo is intended primarily for just that sort of thing ("music as well, of course"). The worst thing they do is to minimise the effect of stereo music.

In fact, if somebody asked me to demonstrate stereo music in such a way that the least possible difference would be detected between mono music and stereo music I would certainly play a highly exaggerated train effect before the stereo music.

It is much better, in my opinion, to offer a good orchestral stereo session, with plenty of colour and variety, and finish with a little of the same material in mono.

And here is the heart of the matter. Too many demonstrators, I imagine, are afraid that a lot of listeners will not notice the difference—or will refuse to acknowledge the difference, which is just as bad for them at that particular moment.

I do not think there is any escape from that one. It is far better that people should gradually learn to appreciate the true value of stereo, and buy it, than that they should promptly appreciate its ability to perform tricks, and decide that they do not want to pay £70—£100 for a mechanical clown in the drawing room.

# There are many uses for tape in Church

SAYS STANLEY JEPSON

THERE are many fields of church work in which tape recorders can play a most serviceable part, and I wonder why we don't hear more about it.

Take, for instance, the voice of the parson, a most important factor in his work. Ah, would some power "the giftie gie us" to hear ourselves as others hear us! Some of these pulpit voices are very good, golden with clear diction and easy to listen to even at the rear of the church. Others are the reverse, and often when clerical vestments are donned and the pulpit mounted, an artificial voice is also assumed—the holy drone, the bishop's boom, the patronising Sunday school-teacher voice, and many others.

Perhaps it is the Scriptural injunction about those "chief seats" which leads people to huddle together at the rear of places of worship, but how often one hears complaints that the preacher could *not* be heard distinctly!

The voices in the B.B.C. morning feature "Lift up your Hearts" are followed by the trained voices of the weather broadcasters, and sometimes the contrast is almost painful.

Some time ago I took part in a revealing experiment in a Jersey church. A number of lay preachers wanted to listen to their own voices, so the drill was as follows. The mike was placed on the pulpit front, and the speakers stood about six feet away, with the volume adjusted by experiment so that the recording was made at a strength equivalent to a good clear voice being thrown to the rear of this building, where the small audience sat. One by one the speakers tried out their voices on a passage of Scripture, and then all were played back while we listened from the rear of the church.

The result surprised them: more than half were not clearly audible.

How seldom does one hear the Scriptures read clearly. What a delight

it is when one hears them read with full and flowing force, with correct variation of pace, with pauses here and there, with the accent on the vital key words, and without any dropping of the voice at the ends of sentences. Of all books, the Bible calls for fine dramatic reading, but most readers are a little afraid of it.

A well-known story concerns a question put by a famous divine to a popular actor: "Why is it that you who speak fiction, can fill your theatre nightly, while I, who preach truth, have an empty church?"

Replied the actor: "Because you preach truth as though it were fiction, and I speak fiction as though it were truth!"

The Bible is a neglected best-seller of great literary beauty; perhaps tapes with selected passages from that book, as lessons in good reading, would serve a useful purpose in churches.

The Methodist Church has the largest body of lay preachers in the world, over 23,000 of them, and the Department concerned with them uses tape effectively. It has issued taped lectures on various aspects of the work, such as sermon preparation methods, and I once heard a good tape by an L.R.A.M. Speech and Drama teacher on Voice Production. This was a real teaching tape, with errors demonstrated in an efficient manner.

Of the preaching of sermons there is no end, and many are the complaints of those which are too long! The sermon which is outlined, then written out and taped is of a known length. Moreover, sermons are meant not to be read but to be listened to, and from the tape the preacher can assess its real value to a congregation which is unable to say: "Stop a minute, I haven't got that . . . let's have that bit again!"

Further, by listening to a tape on several mornings (perhaps while dressing and shaving) the parson can get a clear idea of its outline and phrases, and dispense with all but the barest notes.

This applies, of course, to any public speaker. If you have to do any public speaking of any kind, try this and see! At least you will get a clearer idea of length.

There are many other uses for a tape recorder in such church activities as





and R. J. HEATHORN relates how

## IT HELPED WITH THE VICAR'S PLAY

*As Easter approaches, two contributors describe how tape recording can assist the work of the church in a wide variety of ways—and, in fact, is already doing so.*

week-night meetings. Even at those inevitable bazaars, the machine can be made to bring in revenue through voice-guessing competitions, or even the simple recording of voices for people who have never heard themselves—at sixpence a time.

Missionaries can send spoken messages instead of cold print, and on historic occasions, like stone-laying ceremonies, recordings can be made for future use.

For film strip work in the Sunday School, tapes can be made and played back, making this teaching operation much simpler.

If I were the Provost of a popular cathedral visited by many people, I would go to a tape recorder manufacturer to see if he could design a machine to play ten minutes of tape when the lid was unlocked by insertion of a half a crown.

Headphones only would be used and on the tape could be the sort of information visitors would like to have, historical survey may be a suitable passage of Scripture, with the cathedral organ and choir, and perhaps even an appeal for building repair funds. The tape could reverse automatically at the end.

Many theological colleges now make good use of tape recorders; but no up-to-date church should be without one today.

**Y**OUR local church may be planning to produce a play this Easter, and the chances are that an offer of help in providing the music will be welcome. My local church recently produced a play one Sunday evening in place of the normal service. Written by the Vicar, it called for music to establish the right atmosphere and to fill the intervals when scenery was being changed.

I undertook to do this with my Simon SP/4. The first step was to go carefully through the script. I made a clear mark at every point where music was called for. These marks were numbered in sequence and there were thirteen in all. The Vicar and producer decided what the music should be and gramophone records were secured for transfer to tape on my machine. The Vicar having assured me that the question of copyright had been looked after.

An evening was spent playing the records in their correct sequence in the play and the music was thus transferred to a single length of tape. I left gaps for items three and twelve, because these were to be hymns sung by the congregation. The church organist had a part in the play and so would not be available to play the accompaniments. These were to be recorded beforehand.

This was done one evening in the church. The echo was bad in the empty building, so I placed my ribbon microphone about ten feet from each of the two new column loudspeakers that the church organ feeds and kept the recording level very low. At  $7\frac{1}{2}$  ips the result was excellent.

Although all the music was now on the tape in correct sequence and with no gaps, it was necessary to be able to find individual items quickly for use during rehearsal. I stuck a strip of paper along one rib of the spool and played the tape through. At each point where one item ended and the next began I stopped the tape and drew a firm pencil line across the paper immediately above the outer edge of the wound tape.

This mark was an infallible place-finder, more accurate than the linear counter fitted to the machine. The spaces between the lines were then numbered from one to thirteen to make each easily identifiable with its place in the script.

In one scene, a character sang a Negro spiritual. He asked me to arrange to sound a B flat to start him off. Reference to the script showed that this song came between items eight and nine. In the few inches of tape separating these

items I placed a B flat recorded from the piano at home.

The play was performed in the space between the choir stalls, immediately in front of the altar. As there were no curtains, scenes were changed in total darkness. Spotlights were fitted up to reveal the scene at the right time to the congregation. My recorder was installed on a table in a room at the side, and the lighting expert had his equipment there on another table. My recorder was connected to one of the organ loudspeakers and only half of the available volume was needed when the church was full.

In our room we could not see or hear what was happening on the stage. A microphone was fixed at the edge of the stage and connected to the loudspeaker of an ordinary radio receiver, via a small amplifier. We listened to the play through this, fading our music and lights in and out as required, by following carefully in our scripts. I refused to allow my ribbon mike to be used for this purpose, I was glad I had when the one the producer borrowed was hit by a wooden box during scene-changing.

When the time came for the spiritual I pulled out the external speaker plug to allow the singer to hear his note before he walked on. Thus the audience did not have to hear this key-note, which sounded only through the internal speaker in the operations room.

I derived a great deal of satisfaction from helping with the play in this manner. To anyone else who may contemplate a similar activity, I would offer these suggestions:—

1. Make sure by private practise that you can always find the place quickly. It is infuriating for everyone at rehearsal to be kept waiting while you grope for the right place on the tape.

2. Make sure that you know exactly how the whole play should go and what each person should do. Particularly, close co-operation with the lighting man is essential—music must fade out and lights come on together.

3. Stand your recorder on a table too small to take anything else, or you will find make-up, bowler hats and milk bottles always in your way.

4. Keep the recorder locked whenever you are not actually beside it.

5. Don't erase too soon afterwards. You may find that a neighbouring church has asked for a performance a week or two later.

By careful planning the whole thing was done without any cutting and joining of tape. And the final tribute to the quality of the sound was the discovery afterwards that nobody in the congregation had realised the organ music was recorded. They thought the organist was in his loft.

# LONDON AUDIO FAIR

*Advance information about some of the new models to be introduced at the forthcoming Audio Fair provides an exciting prospect. In our next issue we shall publish a detailed, stand-by-stand survey.*



SPECTONE 171



ELIZABETHAN "MAJOR"



TRUVOX R6



VERITONE VENUS DE LUXE

**N**OT all manufacturers have yet released details of their plans for the Audio Fair, but enough is known to discern the main trends. There is little doubt that the principal one is the move towards four-track 7½ ips performance as a standard.

This development is, of course, far advanced in the United States and one of the most interesting features of the Fair will be the introduction by Ampex of the 4-track 7½ ips tape records being handled by the United Stereo Tapes combination which Ampex has sponsored.

Four-track is also getting ahead rapidly on the Continent, and a variety of such recorders of German origin—machines like the Harting, the Elektron, the Körting, the Chitnis—will be displayed at the Fair. Not present, but nonetheless a significant pointer to the general trend, will be the new machines just announced by Philips and Cossor, described elsewhere in this issue.

New decks, by Gopalco, will have facilities for two-and-four-track stereo and monaural operation.

But British manufacturers are now getting to grips with the challenge. Multimusic will be showing the second machine in their new range, incorporating the new Multimusic deck—and it is a four-track job capable of handling stereo with connection to a suitable external amplifier. There is news, too, of W. & N. Electronics ("Audiomaster") developing a four-track machine, using the Collaro deck.

## Big boost for stereo

The advance of four-track is, of course, inevitably bound up with the development of stereo. Some of these new machines incorporate the dual amplifiers for self-contained stereo but, where this is not so, the trend is to provide for easy coupling to a second amplifying channel to give stereo facilities.

Stereo is undoubtedly going to get another big boost at this fifth Audio Fair. Firms like Ferrograph and G.E.C. will be concentrating, in their demonstration rooms, on showing the virtues of the new sound. And, in the range of amplifiers on show, the stereo trend will be reflected. Leak promise a particularly interesting innovation, the "Varislope Stereo" pre-amplifier, which it is claimed will handle stereo or mono from any pick-up, tape head, tuner or microphone in the world.

Additional interest will be given to the Fair by the enlarged overseas participation which results from easing of the controls during the past year. There will be, in addition to the increased range of German recorders, several exhibitors from America and one from France.

Among the Americans, Ampex is bound to attract much attention. This firm exhibited last year, but enthusiasts will only now have the opportunity to examine the full range of its products.

The French participant is Teppaz, of Lyons, who is bringing over a rather gay range of record players, including an interesting portable stereo player, and a number of amplifiers.

# LONDON AUDIO FAIR

## A preliminary survey

Hi-Fi  
**HARRY**  
by rich

Then there will be, on view for the first time, the impressive range of A.K.G. microphones, from Vienna, handled here by Politechna, as well as the Beyer dynamic and ribbon microphones, handled in this country by Gopalco.

The foreign firms will find, however, that they face very keen competition in standards from British manufacturers. With microphones, for example, the Lustraphone, Acos and Relso ranges will be fully represented, and there will be a new mic. exhibited by Standard Telephones.

### *Speakers . . .*

Speakers will also be well to the fore in the Fair, with Goodmans promising an entirely new 12-watt two-way high fidelity speaker system, and Wharfedale concentrating on a practical demonstration of what good speakers can do to enhance the performance of average domestic recording equipment.

At the last Audio Fair the B.S.R. Monardeck made its debut on a number of machines at the lower end of the price range and it will be much in evidence again this month. The Collaro Studio deck, which was only a rumour a year ago, also appears now as a popular component in a range of recorders.

The Garrard magazine deck will also be seen in several machines recently introduced, including an entirely new Spectone 171. But there has been no sensational spread of the tape magazine idea.

Nor has there been a spectacular development in the field of battery portable machines. The established Fi-Cord will again be well to the fore, but this year we shall be able to see, in addition, the American Steelman Transitate, the popular-priced Grundig Cub, and the all-British Minivox.

### *. . . and Tuners*

Tuners appear in several new guises this year. At least three firms will be showing entirely new models.

Among the range of new tape accessories will be an interesting Waltrak pocket audio oscillator from Wellington Acoustic Laboratories, and a quite new design of tape splicer



***"I should have known you'd have an ulterior motive in suggesting a weekend in London would be a nice change for me."***

which Wilmax are marketing under the "Irish" trade-mark.

And so to the magnetic tape itself. There will be more brands represented among the exhibitors this year than ever before. Scotch are known to be introducing a new line, in the form of a "One-Five Special" three-inch reel (150-feet), in a special pack designed for mailing. F. A. Hughes proposes to push their BASF tape with a film called "The Magic Tape."

Two firms of cabinet manufacturers will be showing the latest, very handsome, designs in hi-fi furniture.

Finally, to complete this preliminary general review, it needs to be revealed that a number of very interesting new recorders of orthodox design can be

expected at the Fair. Two may be quoted as examples—the Elizabethan "Major," a three-speed model with two speakers, for which an exceptionally high performance is claimed, and the Veritone Venus de-luxe, a four-speed machine, with such refinements as a comparator switch to enable direct comparison between input signal and recording.

This article, because it has concentrated on what will be new, has not referred to many established products by familiar firms in the tape recording and hi-fi world. A comprehensive and detailed survey of the Audio Fair will be published in our next issue, which will be on sale the day before the Fair opens.

## The New Decks

OF all the tape recorders and decks I have reviewed, the TM60 is one I would most like to keep. It is a stereo/monaural deck, complete with recording/playback amplifier, but for complete function it requires a twin channel power amplifier and two loudspeakers.

To test it as a complete system, I used my favourite standby, two Mullard 510 amplifiers, complete with corner loudspeakers, each comprising bass, middle register and tweeter units. The TM60 is the answer to the hi-fi stereo enthusiast's problem, for it is a recorder that performs very closely to semi-professional standards; to prove this claim it was subjected to a wide range of tests, including some which I do not normally apply to a tape recorder.

The TM60 does not come cheaply, but, on the other hand, it is real value for its price at 90 guineas. It is constructed and finished to the high standard of all Grundig equipment and carries most of the now generally accepted facilities, the only one of which I can criticise is the recording level indicator. This is a bar-type magic eye and, while there was nothing wrong with its function, I felt that because of the excellent performance of this recorder, a calibrated recording level meter would have been a more appropriate fitment.

The deck carries a tape position indicator, superimposing and interlocking record button, four control keys for stop/start and rewind, microphone, pick-up and radio channel selection controls, a stereo/monaural changeover switch, and an instantaneous stop/start button, which is a most useful facility on this recorder. An indicator light shows when single or two channel record/playback is being used.

### CIRCUIT DETAILS

This review would not be complete without a fairly detailed description of the circuitry, for nothing seems to have been spared. First the power supply, which provides two H.T. sources from selenium rectifiers, one for the relays, which control much of the circuit change-over and mechanism operation, and one for the amplifier.

The record/playback amplifiers, one for each channel, use an EF86 for the head amplifier and a double triode (ECC81) as voltage amplifier. Inputs are provided for two Grundig condenser microphones, gram pick-up or radio output (both channels), so the TM60 lends itself very nicely for recording stereo direct from discs or from a compatible F.M. radio system which, we hope, the B.B.C. will one day provide.

# THE GRUNDIG TM60 MONO-STEREO

BY WILLIAM DOBBS

The record/erase oscillator is most interesting and employs a circuit that intrigued me immensely. One of the problems with stereo recording is the function of the bias oscillator. To use separate oscillators brings the risk of beat notes, and to use a single oscillator means paralleling the tape head circuit and the possible introduction of crosstalk.

Grundig have solved the problem by using an oscillator which feeds one head direct but at the same time drives an RF amplifier (with controlled gain) which feeds the other head.

On playback, the output from each channel is 400mV across 4.7K.ohms, the left-hand channel being usual for monaural. The EF86's which were used as microphone amplifiers now become the tape head amplifiers, with CCIR correction applied in the ECC81 circuits. The amplifiers and bias oscillator are fully screened and mounted beneath the drive mechanism chassis.

The input sockets for the two microphones are mounted in a small screening

box, which also carries the socket for radio or pick-up input. Outlet sockets are at the back of the machine.

I should mention that the TM60 has been designed to work into any suitable stereo power amplifier or into the Grundig Stereo radiogram SO.131.GB.

The machine is supplied complete with two Grundig condenser microphones and a 7 in. spool of tape.

### PRACTICAL TESTS

Stereo recordings were made using the condenser microphones supplied and, for those who are interested, excellent results can be obtained by using the microphones, not spaced as recommended by the makers, but by using an "artificial head." Simply place one microphone either side of a soft cushion or a piece of thick foam rubber about 18 inches square, like an ear each side of a head (see diagram). The stereo effect is far superior to that obtained by recording with the microphone spaced, as it does away with the "hole in the middle" effect, to a very great extent.

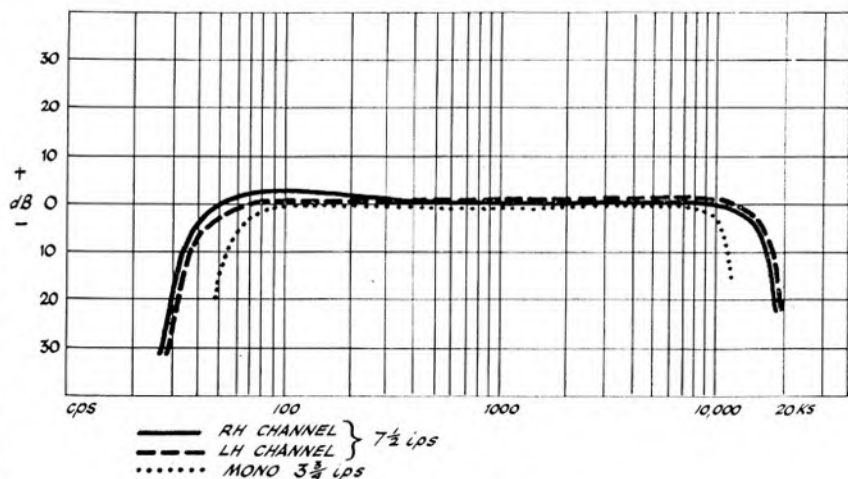

Frequency response test (Ref. 1000 cps)

Left and right-hand channels at 7 1/2 ips

Using the 510 amplifiers, and with the speakers placed about nine feet apart, the stereo reproduction was excellent and a number of interesting recordings were made of various kinds of moving sounds. Music recordings made on this deck are first-class and, as the noise level is extremely low, I took the opportunity of making some copy tapes, in stereo, from my own equipment.

The copy recordings were very nearly indistinguishable from the originals. I could see also many possibilities with this machine for making Musique Concrete.

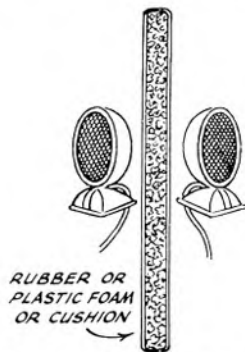

“Artificial head” method for stereo recording with pressure microphones

#### TEST REPORT

The TM60 was given a full range of performance tests and I can honestly say that this is one recorder that not only came up to specification, but was actually better. As any engineer will tell you, this is a rare occurrence.

The first and obvious test was that of equal performance over the two channels, both on record and playback, the E.M.I. TBT1 test tape being suitable for this, as the tape is recorded full-track. The *Tape Recording Magazine* test tape was also used for some of the tests.

Frequency response at  $7\frac{1}{2}$  ips is shown in Fig. 1 and from this may be seen the closeness of the performance for the two channels, which is more than adequate for stereo playback of pre-recorded tapes. By the way, the machine was also aurally tested with E.M.I. “Stereosonic” recordings.

Cross-talk is so low as to be almost negligible, and hum and noise level is better than the maker’s specification of  $-40$  dB. Bias oscillator waveform is pure and strong; evidence of this is the exceptionally low noise level after erasing a recording.

Wow, and its intimately associated phenomenon flutter, were low enough to be unnoticeable, even on test tones, and measurement showed less than the 0.2 per cent quoted for the TM60.

Standard 7 in. spools can be used, so that very long playing times are available using L.P. tapes at  $3\frac{1}{2}$  ips and, although the re-wind times are a little on the slow side, tape spooling under all conditions is accurate. Braking is instantaneous and all other facilities were tested to satisfaction. Superimposing can be carried out on monaural recordings only, and tests showed that an original recording is practically unaffected.

(Continued on page 34)

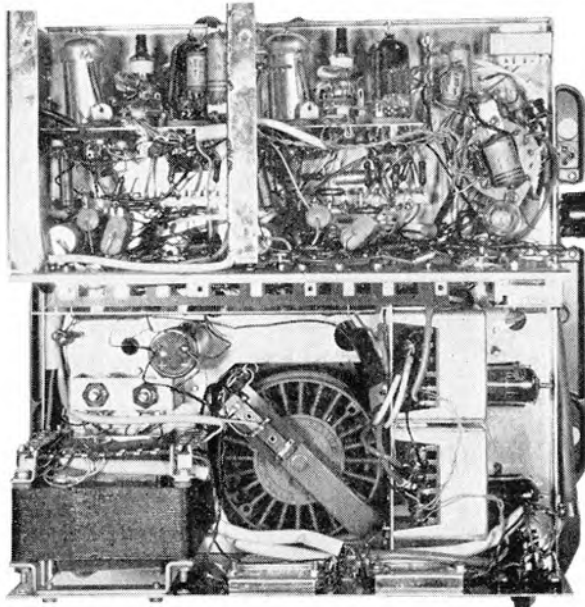
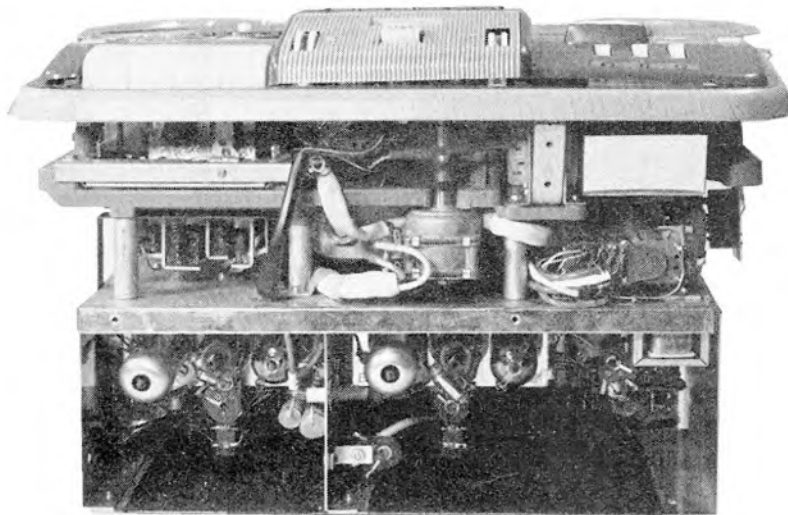
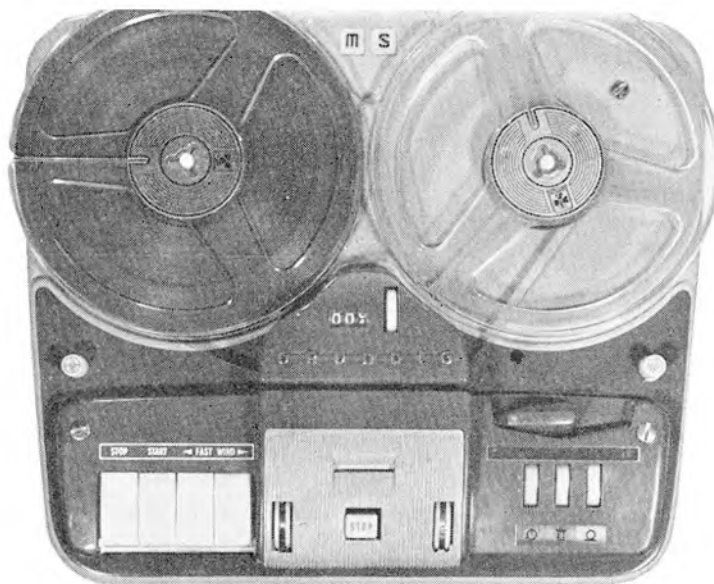

Final article in a series by Richard A. Margoschis

# Building and fitting the amplifiers

**T**HE same detailed consideration that had been applied to the deck was given to the amplifiers. What little knowledge I had of amplifiers was limited to valves, and so the idea of transistors was turned down—for the present, anyway.

I considered that it was not necessary to provide any erase, for this can be done on a mains machine, and its absence eliminates one head and also prolongs battery life. Originally, I intended to fit only one head with recording amplifier but, having worked with the Bradmatic which has proper monitoring facilities (off the tape), I thought that I should be lost without similar facilities on my portable.

The problem of finding a suitable circuit for battery valves was eventually solved with the aid of "Magnetic Recording Handbook," by R. E. B. Hickman, for within its pages I found the circuit of the E.M.I. model L2B. The circuit which I eventually used is shown in Fig. 4, and is the E.M.I. one modified to meet my own requirements.

I had decided to use Bradmatic heads, and so I consulted the makers about the suitability of the circuit. They were extremely helpful; they put me right on the oscillator circuit and also supplied the necessary coils.

The only other modifications are that different valves are used and both high and low impedance microphone inputs are provided. The latter modification makes it possible for me to use either my Reslo ribbon or Acos crystal microphones.

Much of the success of any amplifier lies in the lay-out of its components and, as I am not experienced in this, I feel it is better to mention just a few points rather than to go into details, though photographs No. 5 and 6, will give some idea of my lay-out—and it does work!

The complete amplifier is contained in a chassis of 7 x 5 x 4 inches, and designed to fit into one end of the box which carries the deck. The valves of the record and playback amplifiers are set out in two rows (right of picture), with record nearer to the front panel, while the oscillator valve is on the opposite side, the first valve of each amplifier (V1 and V5) being mounted in anti-vibration bases.

Underneath the chassis the two amplifiers are again separated, with components for record mounted on the front panel, and playback on the rear panel. Both rejector (L1) and oscillator (L2) coils are mounted in such a way that their cores can be adjusted through holes in the front panel.

If more than one of the four 16 Micro F capacitors are contained in any one can, then C6 and C11 (record), and C19 and C22 (playback) should be paired up. Separate H.T. lines should be used for each amplifier, the point X on the theoretical diagram (Fig. 4) being a suitable point of separation.

Separate earthing points should also be provided, right through from each head. I found that these precautions are essential and are, in fact, modifications which I had to carry out to eliminate pick-up from the replay amplifier to the record amplifier, which caused a post-echo to be recorded on the tape.

The low impedance input is by a Belling Lee socket direct to a suitable transformer. C4, R10 and S1 could very well be omitted, though I find that this network is useful in improving the base response of the ribbon microphone when speaking close to the instrument. The high impedance input is by a jack-socket which automatically breaks the low impedance circuit when a plug is inserted.

The position of S2 (ganged with S3) makes no difference to the working of the amplifiers, it simply determines for which of the four purposes the meter shall be used.

The meter, 500 micro-amp, was purchased from government surplus stock. A new scale had to be provided to accommodate the four different items; three are arranged to take separate portions of the scale and the fourth, record level, takes the full scale. This is illustrated in Fig. 5.

Three other switches are used. S6 is a main on/off switch breaking both H.T. and L.T. negatives, while S4 and S5 break L.T. negative to record and playback amplifiers respectively. Thus either amplifier can be used alone or both can be used at once, as when monitoring off the tape. The lay-out of the amplifier controls can be seen in Photograph No. 6.

## THE MARRIAGE

It was now necessary to marry the amplifiers with the deck and the way in which this has been done can, I think, best be seen by reference to the various

(Continued on page 24)

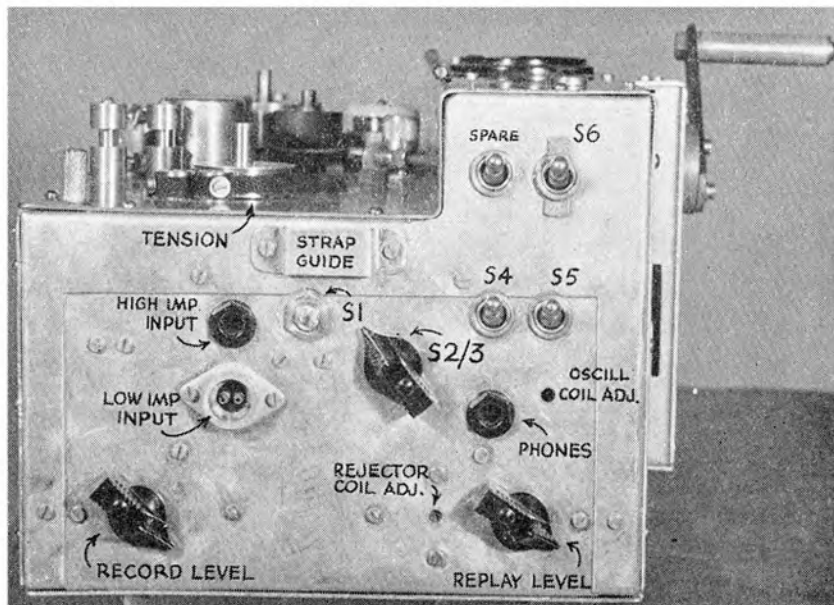

5. INPUTS, OUTPUT AND CONTROLS

**RESISTORS**

- R 1 2.7K
- R 2 4.7M
- R 3 3.3M
- R 4 1M
- R 5 220K
- R 6 10K
- R 7 3.3M
- R 8 680K
- R 9 200K
- R10 10M
- R11 220K
- R12 470K
- R13 2.2M
- R14 47K
- R15 22K
- R16 3.3M
- R17 6.8K
- R18 10K
- R19 18K
- R20 5.6K
- R21 8.2K
- R22 1.5K
- R23 4.7K
- R24 820K
- R25 390K
- R26 2.2K
- R27 10K
- R28 4.7K
- R29 150K
- R30 100K
- R31 3.3M
- R32 1M
- R33 2.2M
- R34 3.3M
- R35 1M
- R36 240OHM
- R37 2.2M
- R38 68K
- R39 10K
- VR1 25K
- VR2 25K

**CAPACITORS**

- C 1 .04Micro F
- C 2 680PF
- C 3 .04Micro F
- C 4 .004Micro F
- C 5 200PF
- C 6 16Micro F
- C 7 .04Micro F
- C 8 .01Micro F
- C 9 .25Micro F
- C10 .25Micro F
- C11 16Micro F
- C12 1800PF
- C13 200PF
- C14 .01Micro F
- C15 .002Micro F
- C16 .25Micro F
- C17 .001Micro F
- C18 .001Micro F
- C19 16Micro F
- C20 .0047Micro F
- C21 1000Micro F
- C22 16Micro F
- C23 .04Micro F
- C24 .04Micro F
- C25 .04Micro F
- C26 330PF
- C27 .04Micro F
- C28 50Micro F
- C29 .01Micro F

**VALVES**

- V1—DAF91
- V2—DAF91
- V3—3Q4
- V4—3Q4
- V5—DAF91
- V6—DAF91
- V7—3Q4

- Meter—500Mic.A
- T1 Microphone Transformer
- L1 Bradmatic Type 1)
- L2 Bradmatic Oscillator Col

RESISTOR	1, 2, 3	4	5, 6, 7, 8, 9, 10	11, 12	13, 14, 15, 16, 17	18	19	20, 21, 22	23, 24	25	26, 27, 28	29	30	31, 32	33	34	35	36	37	38	39
CAPACITOR	1	2	3, 4	5	6, 7, 8, 9	10	11, 12	13	14, 15	16, 17	18, 19, 20, 21, 22, 23	24	25	26, 27, 28	29	30	31, 32, 33, 34, 35	36	37	38	39

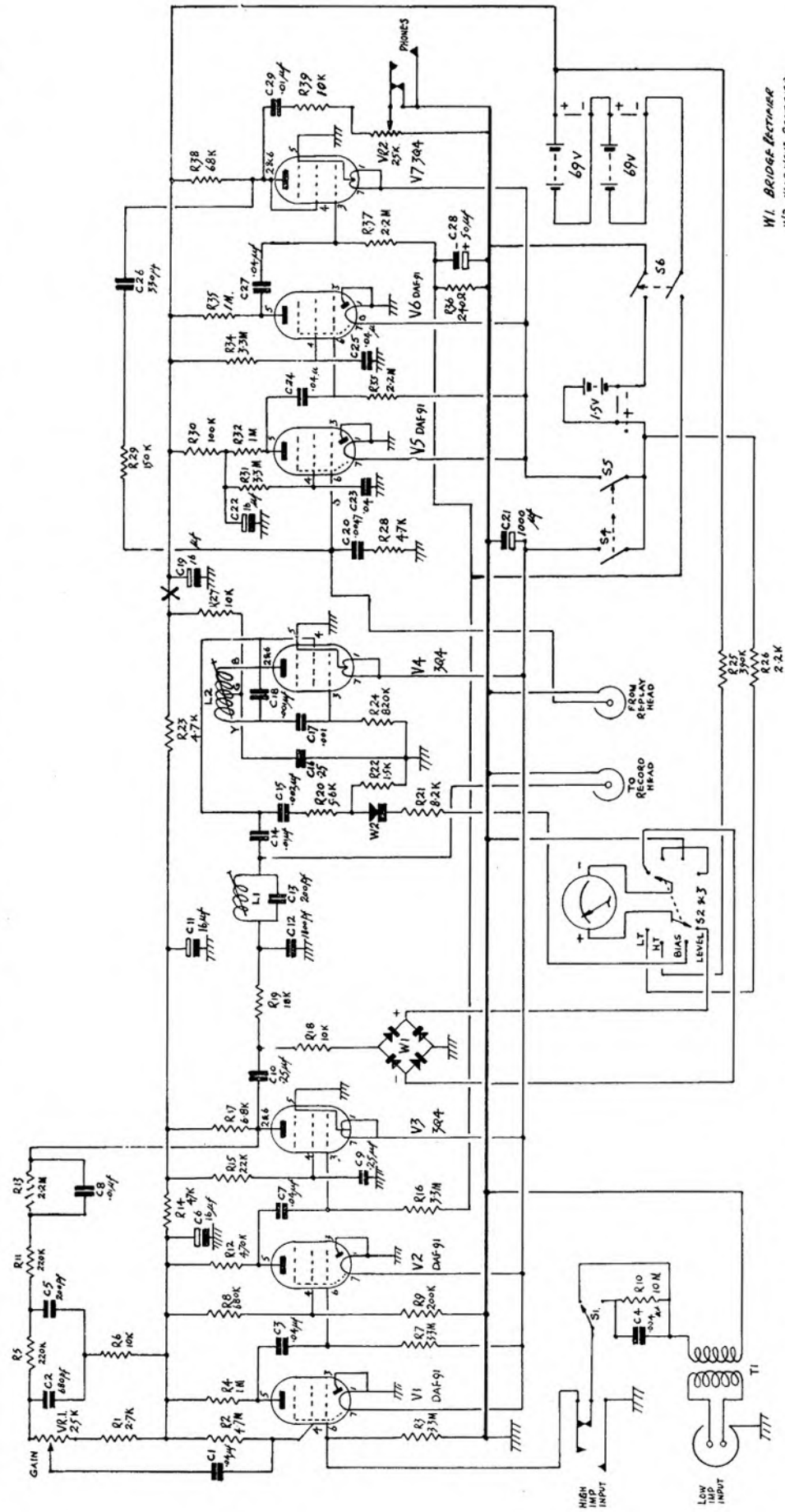

W1 BRIDGE RECTIFIER  
W2 HALF WAVE RECTIFIER

FIG. 4.

BATTERY OPERATED RECORD AND REPLAY AMPLIFIER

# TAPE TO DISC SERVICES

TAPE RECORDER HIRE  
TAPE TO DISC 78-LP  
RECORDING STUDIO  
SALES—EXCHANGES

## MAGNEGRAPH

1, Hanway Place, London, W.1.  
s.a.e. for leaflet or  
telephone: LAN 2156

### SSS Private gramophone record made from your own tape

Microgroove LPs from 20/6  
Standard 78s from 10/6  
Mobile Unit available for Weddings, Receptions,  
Choirs, Meetings, etc. S.A.E. for full details:—  
John Leviss, Sunderland Sound Services,  
28, Viewforth Terrace, Sunderland S7032  
■ If you can hear it—We can record it! ■

### RAPID Recording Service

78's and L.P.'s from your own tapes.  
Master Discs and Pressings.  
Recording Studio  
equipped with Bechstein Grand.  
Practising studios  
with or without accompanist.  
Mobile Recording Van.  
"Off the Air" Service.

21, Bishops Close, Walthamstow, E.17. COP 3889

### TAPE TO DISC RECORDING

Microgroove LP from 27/6d.  
78 rpm from 11/-  
Also 45 rpm

#### 48 HOUR SERVICE

S.A.E. for comprehensive leaflet to:—  
Marsh, "Deroy" Sound Service, Little  
Place, Moss Delph Lane, Aughton, Orms-  
kirk, Lancashire. Tel.: AUG 3102

When writing to manufacturers for information about new products, please mention that you "saw it in Tape Recording and Hi-Fi Magazine"

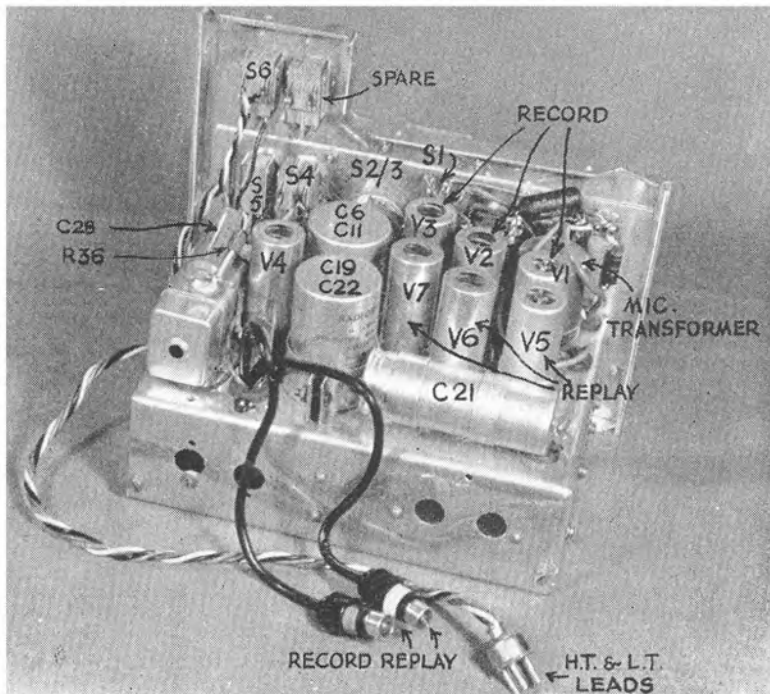

### 6. THE AMPLIFIERS

(the oscillator coil is at the forward left corner of the chassis)

(Continued from page 22)

photographs which have been published with these articles.

The final deck was prepared from 18-gauge steel and suitably bent; after all the necessary holes had been cut, drilled and tapped, it was sprayed.

All the fittings were then transferred from the temporary deck and the necessary adjustments made. The remainder of the box in which the machine is contained is constructed of 18-gauge aluminium.

I find that this material is quite easy to cut and bend. To cut it, I use an ordinary fret-saw; this eliminates the necessity of bending the sheet metal, and gives a cleaner cut than shears; it is also very handy for cutting out the larger holes. If the saw does tend to bind, a smear of oil will help it along wonderfully.

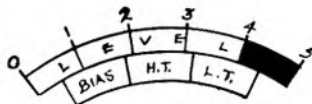

FIG. 5.

The overall dimensions are 17 inches long, 9½ inches wide, and 6½ inches high. As the machine hangs on the left shoulder the front of it rests against the operator's side, leaving the winding handle and starting lever free for operation with the left hand.

The amplifier is then in the forward position and its controls easily accessible to the right hand. The batteries are stored at the other end and so placed as to balance the whole machine on its carrying strap. In the latter compartment there is also stowage space for the crystal microphone and headphones. The front panel of the box is secured with self-tapping screws and is easily removed for servicing. The amplifier can similarly be removed.

The only work now necessary was to carry out the final adjustment to the two heads for azimuth, etc. I found it fortunate that the Bradmatic works are not very far from my home, and again they very kindly helped me. When I took the machine over to them they made the necessary head adjustments for me.

The following day I was out in the country to get experience in handling the machine and I can truthfully say that it was a very satisfying experience for, after all, it was a day to which I had looked forward for two years.

Previous articles in this "do-it-yourself" series appeared in the issues dated February 24, March 9 and 23. Copies may be obtained at 2s. each (including postage) from *Tape Recording and Hi-fi Magazine*, 7 Tudor Street, London, E.C.4



# Equipment Under Test

## THE NORFIELD CONSOLETTA



**T**HE Norfield Consoletta tape recorder is a unique British-made instrument with a most elegant shape. It is dual purpose; it may be used as a completely portable recorder, or set up on three contemporary-styled legs to bring it to the right height for comfortable armchair operation. This does away with the need for a table.

While I greatly favour the idea, I am not sure that I like the angle of the deck when the machine is set on its legs. The deck slopes towards the back of the recorder, making it a little difficult to read the tape position indicator.

A three-speed Motek deck is used, and tape travel is right to left, instead of the standard left to right. I have already reviewed this deck, and found it to be quite favourable. It carries the usual facilities of tape position indicator, pause control, fast forward and reverse re-wind (which it does in under a minute for a full 7-in. spool of tape).

Operation for record/playback and re-wind is by push buttons which, on the machine sent for review, seemed a little stiff. The volume and tone control, the magic eye recording level indicator, and two output jacks are conveniently arranged on the amplifier panel, which is at the front of the cabinet.

Another good thought is the microphone and spare lead compartment also located at one end of the control panel. One doesn't have to fiddle at the back for microphones and spare leads.

The microphone supplied with the recorder is one of the latest Acos crystal

types, which has a good response for speech and, if one is not too critical, for music as well. The radio or pick-up input socket feeds directly into the recording amplifier and "through" monitoring is available when recording from this input.

The instrument may also be used as a record player by connecting to an external pick-up, this same "through" amplifier facility being available for the microphone as well.

The Consoletta is supplied complete with a 7-in. spool of tape, full instructions for operating and, of course, the microphone. The three all-metal legs are available at two guineas extra.

The colour scheme of the recorder is attractive, and employs a coffee and cream shaded dull leatherette covering, which is enriched by nicely-made gilt fittings. The deck itself is finished in similar colours.

### PERFORMANCE TESTS

These included the frequency response test, which for  $7\frac{1}{2}$  ips is shown in Fig. 1 and is within 3 dB or so of the specification at the extreme ends of the frequency range. At  $3\frac{1}{2}$  ips the response falls gradually from about 5,000 cps and was -5 dB at 10,000 cps.

The treble lift control provides approximately 10 dB lift at around 12,000 cps.

Music and speech reproduction is up to the standard of the better class domestic machines, but I found the hum and noise level to be -40 dB and not as quoted in the specification. This was contributed by grid hum rather than

valve noise, which was well below the figure given above.

Wow and flutter were within specification, but pressure pads had a tendency to vibration at  $7\frac{1}{2}$  ips and I found tape spooling to be a little uneven, although central on the spools.

The controls all functioned properly and in accordance with the instructions. The digital tape position indicator was also checked and, like all these counter type indicators, was accurate enough to find a given position on the tape.

The amplifier consists of a printed circuit design using an ECC83 and ECL82 for audio function with a 6X4 rectifier for HT supply. An ECC82 provides the recording bias and, as this valve is operated as a "push-pull" oscillator, the very clean waveform produced by this type of circuit ensures noiseless and clean erasure.

The fitted loudspeaker is a  $7 \times 4$  in. elliptical type and, if desired, an extension speaker can be used while the internal speaker is switched off. A combination extra speaker socket and switch are fitted at the back of the recorder.

The Consoletta should more than satisfy the demand for a very stylish recorder with a nice performance. My one final criticism concerns the lid, which I feel should be fitted with some kind of stay or strap to prevent it lying back with its weight carried on its hinges.

This instrument should find a place among the many new recorders now appearing on the market at prices a little more attractive to the majority of people, and it should certainly score points for its new conception of modern style.

The Norfield Consoletta is manufactured and distributed by Birmingham Electronic Products Limited, 1, Lodge Road, Birmingham 18, and is priced at 48 guineas. **W. D.**

### MANUFACTURER'S SPECIFICATION

Mains voltage, AC 200-250 v 50 cps.  
Consumption, 80 watts.  
Tape speeds,  $1\frac{1}{2}$ ,  $3\frac{1}{2}$  and  $7\frac{1}{2}$  ips.  
Playing time (double track), 4 hrs. 16 mins., 2 hrs. 8 mins. and 1 hr. 4 mins.  
Frequency response, 40 to 16,000 cps at  $7\frac{1}{2}$  ips; 40 to 10,000 cps at  $3\frac{1}{2}$  ips; 40 to 6,000 cps at  $1\frac{1}{2}$  ips.  
Signal to noise ratio, better than 50 dB.  
Wow and flutter, better than 0.25 per cent at  $7\frac{1}{2}$  ips.  
Inputs, microphone, 5mV radio or P.U., 1 volt.  
Power output, 3 watts.

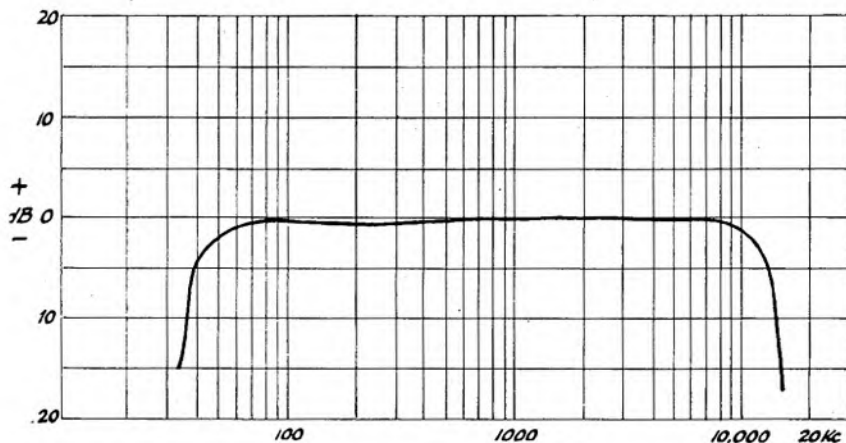

**Frequency response of the Norfield Consoletta recorder**  
(taken at  $7\frac{1}{2}$  ips—reference frequency 1,000 cps)

# Sound Effects

By ALAN  
EDWARD BEEBY

**T**HIS article is the last, for the time being, on Location Recording, and there is one more effect we must cover—CROWD NOISES.

One has only to reflect upon the many times in which crowd-scenes are featured in dramatic and documentary productions to recognise the advantage of having the required sound effect to hand.

The recording of the effect itself is quite simple, provided that one or two basic rules are observed in preparation.

First of all, where and how to obtain your "crowd." I solved this problem by enlisting the aid of the sports section attached to one of our local Men's Clubs. They numbered about 80 altogether and practically all my present "crowd" effects were recorded by them on the same evening.

The effect was divided into six separate parts, each lasting for approximately one minute. These included cheering, shouting, jeering, angry-voices and a three-cheers effect: As an afterthought, I asked them to mark time irregularly with their feet and talk amongst themselves, and the result was a most convincing effect of mass crowd-movement.

Now to the details. Firstly, don't rely on the corny old dodge of asking your "crowd" to keep on repeating either "rhubarb" or "strawberries and raspberries"; it's a waste of time. Should even a dozen people chance to fall into unintentional synchronisation all sense of naturalness and spontaneity will lose itself in a "sound-pattern." Ask each member to bring a newspaper and to read from it at random.

I found that a good idea was to form the members into a rough circle around and some distance away from the microphone and to slowly revolve the mike so that it covered fresh ground almost continually. This helped to lesson both the "block sound" encountered by grouping the people together in a fixed position and the accompanying risk of throwing the front-row voices into prominence throughout the recording.

Don't arrange for them to begin shouting altogether on a pre-arranged signal;

if it *was* arranged it will *sound* arranged and consequently false. One man should begin, his neighbour following immediately after him and so on through the entire group, giving a more natural build-up of noise.

You may wish to include the effect of an angry mob advancing and getting louder in volume as it draws nearer. Bringing up the gain from zero-setting to full-strength is *not* the best way of achieving this effect. A convincing impression of distance can be obtained, however, by employing the "muting" trick recommended for Factory Noises in the last issue.

Shut yourself behind a closed door, signal for the group to commence shouting, set the tape in motion, then open the door slowly.

One final tip. At the beginning and end of each of your "crowd" effects, leave a fairly wide mixing-margin. By this, I mean that you should run the tape at recording-level—for a few seconds—before bringing in the effect-noise and allow the same amount of licence at the end. This renders the transition from outdoor to indoor acoustic "atmosphere" far less noticeable in "dubbing" work where the rest of the recording may be studio-produced. This change is often subtle enough to pass unnoticed by the unwary but it will soon be painfully evident when underlined by a too-quick flick of the mixer-knob for sheer want of a little more margin on either side!

The same applies, of course, to all Location Effects where there is an unavoidable contrast in acoustics to the comparatively "dead" studio sound.

Now let's sum up the case for Location Recording. I need not remind you that it is in this field that the battery-operated recorder really comes into its own. Apart from its ease of transport and operation, it has the added advantage of being completely independent of mains electricity supply and the attendant worry of plugs, sockets, adaptors and yards of cable for people to fall over.

Keep the following rules in mind when

you're out "sound-hunting" and you won't go far wrong.

**DON'T** wander on to Railway, Government, Industrial, Private or any other sort of property without official permission.

**DO** make sure that it *is* permission and in writing if possible.

**DON'T** be put off with: "The Boss says it'll be all right." If the Boss didn't say any such thing, you could find yourself in trouble.

**DO** be careful, when using a mains recorder on location, with trailing cables, etc. Innocent people might easily trip over them and injure themselves *and* your machine by sending it crashing to the ground. A claim for injury, plus the expense of a major repair adds up to a rather expensive sound effect!

**DON'T** stand and gossip to an employee engaged upon a job of work. If the management has been kind enough to grant permission for the recording, show your appreciation by being as unobtrusive as possible in order that normal routine may not be disturbed.

**DO** remember that personal "Thank-you" to the one from whom permission was originally received. It goes a long way towards securing any assistance you may need for future recordings.

Finally, while you're out and about with that battery-portable, don't forget to collect one or two little "gems"; they're always handy to have in stock. The ring of the shop-keeper's till, a barrel-organ, a road-drill, church bells, fairground-noises and so on.

In the next issue, I have some ground to make up on sound effects proper, plus some queries to answer. I also have a little explaining to do on the subject of manufacturing and recording *real* explosions in preference to the faked variety which I recommended in an earlier article.

Someone, it seems, has discovered that I have been in the habit of doing just that; consequently, I am called upon to defend myself!

Well, I'll do my best. See you in a fortnight.

## ESSEX TAPE RECORDER

PART EXCHANGE  
SPECIALISTS

• CENTRES •

UNIQUE EASY  
H.P. TERMS

Largest Tape Recorder Stockists in East London and Essex—over 200 Models in stock

205 High St. North, East Ham, London, E.6 | 2 Maryland Point Station, Stratford,  
(opp. East Ham Station) Tel: GRAngeewood 6543 | London, E.15 (Head Office) Tel: MARYland 5879

# TWO MAJOR FIRMS TAKE TO 4-TRACK

## Philips enter stereo field



New  
Products

## COSSOR—NEW RECRUIT TO TAPE

COSSOR RADIO AND TELEVISION LTD., announce the introduction of their first domestic recorders, the CR 1601 and the CR 1602. Both are designed for four-track operation.

The CR 1601 has three speeds,  $1\frac{7}{8}$ ,  $3\frac{1}{2}$ , and  $7\frac{1}{2}$  ips. Frequency response is given as 50—12,000 cps at the highest speed, and 50—7,000 cps at  $1\frac{7}{8}$  ips. Wow and flutter is said to be less than 0.2 per cent at  $7\frac{1}{2}$  ips, and less than 0.3 per cent at  $3\frac{1}{2}$  ips. Signal-to-noise ratio is quoted as better than -40dB.

Monitoring can be carried out with headphones, and there are also facilities for mixing and superimposition. Other features include safety erase lock, tone control, pause control, magic eye recording level indicator, rev. digital counter, and extension speaker sockets.

The recorder can be used as a straight-through amplifier, and with a suitable additional amplifier can reproduce stereo tapes. A built-in five-inch high loud-speaker is provided with an output of  $2\frac{1}{2}$  watts. Consumption is given as approx 60 watts. The size is  $16\frac{1}{2}$  x  $14\frac{1}{2}$  x  $7\frac{1}{2}$  in., weight 30 lb.

A moving-coil microphone with speech/music switch is included in the price, of 59 guineas, together with a 7 in. spool of double-play tape.

The second Cossor recorder has a single speed of  $3\frac{1}{2}$  ips, with a quoted frequency response of 40—14,000 cps. Wow and flutter is given as less than 0.3 per cent, and signal-to-noise ratio as better than -40dB.

The same facilities are provided as with the three-speed model. Main differences, apart from the single-speed, is the size:  $15\frac{1}{2}$  x  $12\frac{1}{2}$  x  $6\frac{1}{2}$  in., the weight, 19 lb., and inclusion of a crystal microphone in the price, of 37 guineas. A five-inch spool of long-play tape is provided, although seven-inch reels can be accommodated.

The CR1601 is housed in an attractively-styled portable cabinet, covered in plastic cloth, with a detachable lid. A wooden cabinet covered in two-tone washable plastic, with a detachable lid, houses the CR1602.

*Cossor Radio and Television Limited, 71, Endell Street, London, W.C.2.*



The two new Cossor recorders, CR1601 (left) and the CR1602

PHILIPS have extended their range of recorders with two new models. Both are three-speed four-track machines, one stereo/monaural and the other monaural only.

The new stereo recorder is the EL 3536, (top left) at 92 guineas. It operates at  $7\frac{1}{2}$ ,  $3\frac{1}{2}$  and  $1\frac{7}{8}$  ips. It accommodates 7 in. spools, so that at the middle speed, using long-play tape, it plays for six hours monaural or three hours stereo.

Output is rated at four watts per channel and the makers quote frequency response at 50 to 20,000 cps at  $7\frac{1}{2}$  ips and 50 to 7,000 cps at  $1\frac{7}{8}$  ips. At the top speed wow and flutter are quoted at less than 0.2 per cent; the signal-to-noise ratio is given as better than -40db, and cross-talk separation at better than 50 db.

This recorder is housed in a wooden cabinet measuring  $20\frac{1}{2}$  x  $15\frac{1}{2}$  x  $11\frac{1}{2}$  in., covered in two-tone blue and grey washable plastic, and has a reinforced plastic carrying handle. The weight is 43 lb.

A 6 x 4 in. speaker is built into the main cabinet and a  $6\frac{1}{2}$  in. speaker for the second channel is housed in the detachable lid.

The various input and output sockets are easily accessible through cut-outs at each end of the cabinet. Controls are finished in white—except record interlock and tape pause buttons, which are coloured red.

Superimposition facilities are provided.

A stereo moving-coil speaker is supplied and one moving coil element only is automatically selected when the recorder is switched to the monaural position.

The second new Philips machine, model EL 3542 (centre left), costs 59 guineas. This also has superimposition facilities and a special socket is provided for linking an external amplifier and speaker to convert the recorder to stereo.

The cabinet is smaller— $15\frac{1}{2}$  x  $13$  x  $6\frac{1}{2}$  in.—and the weight is 30 lb.

Similar frequency response, wow and flutter and signal-to-noise ratio figures are quoted by the makers.

The built-in speaker is a 5 in. one and output is rated at  $2\frac{1}{2}$  watts.

The machine has a "magic eye" level indicator and a digital counter. A moving-coil microphone, with a built-in speech/music switch, is supplied.

*Philips Electrical Ltd., Century House, Shaftesbury Avenue, London, W.C.2.*

# IS YOUR TAPE RECORDER INSURED?



A Norwich Union policy provides cover in respect of accidental damage or loss, fire and burglary for

**ONLY 10/- A YEAR**

(Electrical or mechanical breakdown excluded)

Post the coupon NOW for full details to

## Norwich Union

INSURANCE SOCIETIES

16-26 Surrey Street, NORWICH, NOR 88A.

You may send me (M) .....  
without obligation,  
details of Norwich  
Union Policy for  
tape recorders, etc. Address.....  
.....T.R.12

# NEW! DO-IT-YOURSELF TRAINING TECHNIQUE in RADIO & ELECTRONICS

You LEARN while you BUILD...

SIMPLE...PRACTICAL...FASCINATING...

ANNOUNCING—after years of successful operation in other countries—the latest system in home training in electronics introduced by a new British training organisation. AT LAST—a simple way of learning—by practical means—the ‘how and why’ of electronics with the minimum of theory and no mathematics! YOU LEARN WHILST BUILDING actual equipment with the components and parts which we send you—and you really have fun whilst learning! And afterwards—you have a first-rate piece of home equipment plus the knowledge of how it works and how it can be serviced. THIS NEW SYSTEM brings an exciting new opportunity and is very moderate in cost. Post the coupon now without any obligation for full details.



BUILD YOUR OWN:—

- RADIO EQUIPMENT
  - HI-FI INSTALLATION
  - TEST EQUIPMENT
- AND LEARN AS YOU DO IT

LOTS OF INSTRUCTIVE  
EXPERIMENTS AT HOME!

**No Mathematics!**

**FREE-**  
**POST TODAY**

To: RADIOSTRUCTOR (Dept. G35)  
46 Market Place, Reading, Berks.  
Please send Brochure without obligation to

Name.....  
Address.....  
(812).....

BLOCK  
CAPS  
PLEASE  
11-59

# RADIOSTRUCTOR

BRITAIN'S LEADING ELECTRONIC TRAINING ORGANISATION

what  
goes on  
in tape?

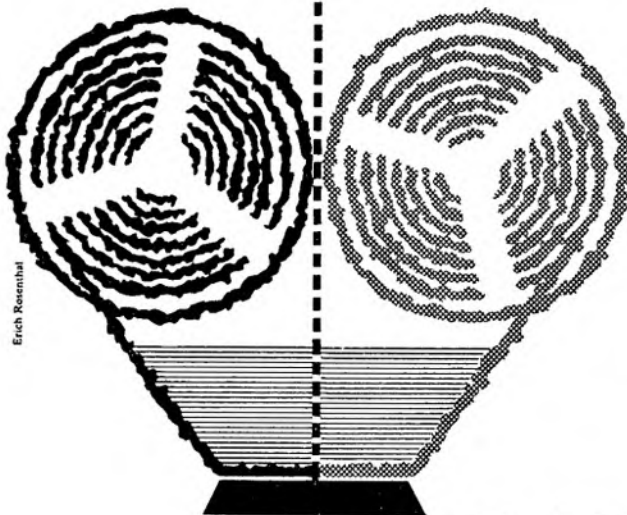

R. B. TAPES know! The best recorders of today  
are always in stock and our

organisation is in the forefront of the  
latest developments in  
this exciting field.

All our machines may be bought on very  
convenient terms under our own  
12-months guarantee and our famous  
free after-sales service. We specialise in  
conversions. Write or call for free booklet!

▼ AGENTS FOR ▼

WYNDSOR GRUNDIG  
TELEFUNKEN ELIZABETHAN  
ABBEY SIMON  
SPECTONE VERITONE  
SABA SOUND

# R.B.TAPES

NORTH LONDON'S LEADING TAPE-RECORDER AND RECORD SPECIALISTS

179 STOKE NEWINGTON HIGH ST  
LONDON N16 CLISSOLD 9477

**P**UBLICITY, the keynote of any organisation, is gradually making itself felt among clubs. In many of the reports I receive nowadays, I hear of the various ways the clubs are extending their boundaries by well-sited public notices and activity reports in local papers.

Most recent of these reports came from Coventry, where leaflets distributed to recorder dealers by Henry Hopfinger encouraged the appearance of several new faces at the March 3 meeting of the **Coventry** club.

The meeting started with a quiz produced by Howard Freer. Messrs. Palmer and Phillips were joint winners and an eliminating contest, to determine the winner of a spool of tape, was arranged for later. After the interval several members grouped up with a Telefunken recorder to make a tape to the San Francisco tape club.

The evening concluded with a re-playing of one of the tapes, made seven months ago by Chairman Roy Reynolds and Ted Bright, consisting of recorded impressions by Coventry dwellers on the re-building of their city.

The Chairman announced the addition to the club's library of an interview with the City Architect recorded by Messrs. Freer and Hopfinger, and a report on the visit to the Birmingham club was made by Roy Reynolds.

Permission for a visit to the new Telephone Exchange and a tour of the Sorting Office is eagerly awaited by members.

It has been another busy month for Henry Hopfinger, the club's great asset, the member who unselfishly devotes much of his time to club matters, and who unhesitatingly offers his services for recording assignments.

Apart from the distribution of leaflets already mentioned, he has recorded an interview with four Cuban journalists who recently visited the city, and taped the opening ceremony, on the club's behalf, of the new Herbert Art Gallery. Incidentally, the permission secured by the club for this recording provides further proof that members are fast becoming recognised as a significant group in the life of Coventry.

Howard Freer and Tom Bageley are also sharing the location recording activities. Former Play-reading group member Shirley Lakin was married to a Yugoslav last month, and these two members taped the wedding and presented the tape to Shirley so that her in-laws in Jugoslavia could hear the service.

**Walthamstow and District** club members also gained a little publicity for themselves recently. The first public notice followed their visit to the local bus and trolley depot where they interviewed the transport staff for their views on the changover to Routemaster buses. A detailed account of the occasion appeared in the *Walthamstow Post*. An edited tape on the evening's work will be given to the Borough librarian. It is hoped to follow a similar pattern in connection with the electrification of the Liverpool St.—Chingford railway line.

At a later meeting, a *Walthamstow Guardian* photographer was present to take photographs of a play rehearsal.

# News from the Clubs

**Edited by**  
**FRED CHANDLER**

Over twenty enthusiasts attended, including members of the **Stoke Newington** club.

Information regarding the Walthamstow club is available from the Secretary, J. A. Wells, 178, Selwyn Avenue, London, E.4.

**Warwick and Leamington** Society members entertained members of the Coventry club at their latest meeting when the judging of competition tapes of *Musique Concrète* formed the major item in the programme. Six tapes were submitted, and the prize of a Silver Cup and spool of tape went to Terry Draper, who produced his tape by combining the ticks of two clocks, a few notes of a music box, and the sounds made by his two children striking an empty vase and a champagne glass. A humorous tape of unusual sounds entered by Geoffrey Collins was judged to be an excellent runner-up.

The visitors from Coventry had with them two portable recorders and recorded many of the tapes entered in the competition. Intensive competition among Coventry members will no doubt arrive from their foresighted action.

Jack Willis, one of the Society's blind members, has moved to Rugby where he works at the B.T.H. factory. The move should make things easier for him, and Leamington's loss will be Rugby's gain, for he intends to join their tape society. Jack has been such a popular member of the Leamington Society that it was unanimously agreed he be invited to remain an honorary member.

The latest March meeting of the Society saw Secretary Brian Race giving an illustrated talk on tape correspondence. During their two meetings this month, Malcome Horne will demonstrate his hi-fi equipment, and Miss Eileen Jones, Publicity Officer, will present a programme of recordings made at home and abroad on a Fi-Cord.

Two new recorders were on view at the latest meeting of the **Ipswich** club. Secretary Malcolm Wilding demonstrated the Philips EL 3515, and Mr. J. O. Clover introduced the portable EMI L2B/TA. After the demonstrations, a tape received from the Brighton club was heard, and members settled down to record a reply straight away.

Weddings feature with this club also. John Hooper recently travelled to London to record the service for his brother, and a second service is to be recorded by other members shortly.

Members would like to exchange tapes with other groups and clubs. Contact Mr. Wilding at 31, Darwin Road, Ipswich, Suffolk.

**Millom** tape club members are steadily increasing their overseas tape contacts.

They have recently received tapes from Durban and Windhoek, South Africa, A.T.R.A. in Australia, and Christchurch in New Zealand. They would like to hear from any enthusiast or group of enthusiasts abroad. Write to Secretary Ken Thompson at "Freya," Haverigg, Millom, Cumberland.

Home-made equipment is still being built, the latest addition being a microphone stand. With the three long cables and a Grundig mixer unit already possessed, versatility is much improved.

A number of money-making schemes are being developed. The cash is needed for a battery portable recorder.

A recorded interview with conductor Mr. Eric Ball has been added to their collection of celebrities.

The ladies seem to be taking the initiative more than ever nowadays. Latest club to be formed is in Hertfordshire, where Mrs. Sheila Wakely and Mrs. Campbell organised the inaugural meeting of the **Ware** club on March 28.

Exact details of the formation were not to hand at the time of writing, but any interested persons are invited to contact Mrs. Wakely at 3, Chadwell, Ware, Herts (Ware 807).

Another group in formation is led by C. K. Young, 28, Chelmsford Drive, Wheatley Park, **Doncaster**. No further details are as yet available.

An interesting evening was spent recently by members of the **Reading Cine and Tape Society** when EMI representatives gave an enlightening talk on the history and development of magnetic tape. Members' questions were answered and an open discussion followed which proved of great benefit to members.

A later meeting of the club was devoted to tapes produced by members of their activities during the Christmas period. Plans for future meetings include a pre-recorded tape evening and a demonstration of portable recorders.

News of a club formed just before Christmas gives tape exchange enthusiasts a chance to hear about that England on the other side of the world—**New Zealand**. The club is in Dannevirke, pop. 6,000, in Hawkes Bay, New Zealand. It has a membership of 35, seven of whom belong to World Tape Pals. Meetings are held once a month, with an average attendance of twenty. A variety of recorders are owned including Grundigs, a Ferrograph, Collaro, Walter, Brenell, Saja, Philips, and one with an intriguing name—La Gloria.

The Club Captain, as he is known, is Mr. R. Mackenzie. He is a photographic enthusiast, and recently provided a tape and 35mm slide show of a tour of the North Island with each slide described in detail on the tape.

The recently formed **Northampton** club has decided that it will cater for both tape and cine enthusiasts. Starting with six members at their inaugural

(Continued on page 31)

To  
keep  
your  
tapes

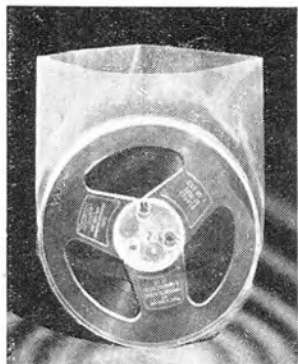

in  
perfect  
order

**use TAPE PROTECTORS!**

Made from top-quality polythene, and having a generous "turn-over" closure, they protect your tapes from dust and atmospheric changes. Equally necessary for both pre-recorded and virgin tapes, they are the answer to "sticking."

In packets of 12: 3"—1/6d.; 4"—1/8d.; 5"—1/9d.  
5½"—2/-; 7"—2/4d.; 8¼"—2/8d.

FROM YOUR DEALER; OR WRITE TO US, ADDING 6d. POSTAGE

**Swains**  
Papercraft Ltd.

Dept. 6,  
Buckhurst Hill,  
Essex.

**TRADE  
ENQUIRIES  
INVITED**



ALL YOUR  
RECORDINGS CAN BE  
FOUND QUICKLY AND  
EASILY BY USING —

**METRO-TABS**

3/11 per set

A new and scientific device designed to clean the Record and Erase heads of your tape recorder, and to reduce faults caused by oxide deposits. Price 12/6



Write for illustrated leaflets to:

**METRO-SOUND MFG., CO., LTD.**

19a BUCKINGHAM ROAD  
LONDON - N.1  
Telephone: CL1ssold 8506/7

**FREE H.P!**

- ★ NO INTEREST CHARGES ★
- ★ 1/- IN £ DEPOSIT ★
- ★ 2 YEARS TO PAY ★



**We have the Biggest Sales in Gt. Britain.  
Why? Because we give the Best Terms!**

SPECIAL FREE TAPE OFFERS ★ FREE DELIVERY ANYWHERE IN U.K. ★  
FREE SERVICING FOR 12 MONTHS ★ NO P/TAX ★ PART-EXCHANGES &  
SECOND-HAND MACHINES ★ 250 machines, 40 models in stock ★ Mail Order  
Department covers the whole country ★ Open all day Saturday ★ Main Agents for  
all the best makes ★ Write, 'phone or call NOW for free brochures and full details of all our items:

**HOWARD**

**PHOTOGRAPHIC**

218 HIGH ST · BROMLEY · KENT · RAV 4477

(Continued from page 29)

meeting at the end of February, the club attracted a further four members at the second meeting and doubled its membership at the March 8 meeting. Meetings are to be held at the home of Secretary John Harrison once a week, mainly on Tuesdays.

A lecture on microphone technique was presented by the Chairman, Mr. Finimore, at their March 1 meeting. He also demonstrated his Leavers-Rich equipment. Even if a single-minded enthusiasm led to the formation of the club, the members prove they don't agree wholeheartedly on recorder preference, for each has a different model.

Outlined for future activities is a scheme to film and record on location. Just now they are adding sound to a holiday film. The Secretary's address is 36, Spring Gardens.

Thunder, lightning and pouring rain heralded the March 10 meeting of the **Rugby** club giving members an excellent opportunity to record some sound effects. The meeting was well attended in spite of the weather and those attending were rewarded with a stereophonic music demonstration presented by Messrs. J. Hack and G. W. Newstead on a Decca stereo radiogram.

The **Acton** Tape and Hi-Fi club has quickly picked up its stride from the initial announcement of its formation. At one of their early meetings, March 8, members elected Eddie Worrall to serve as Chairman, Gerry White as Treasurer, and Dave Wiseman as Secretary. Directly after the committee's election the new Chairman began a demonstration of the Elizabethan "Avon."

A discussion on sound effects followed and the evening ended with ideas and suggestions for flying saucer effects.

At the meeting eight days later, the club welcomed members of the Willesden Motor-cycle club to a demonstration of the new Philips four-track stereo machine.

Some heart in mouth activity preceded the meeting, due to the non-arrival of the machine ordered by Mrs. Rusty Chapman, club organiser. Mrs. Chapman rang her dealers who promised to do what they could, and they produced the machine only two hours before the meeting started.

Mrs. Chapman used two Richard Allen speaker enclosures with the EL 3536, to play an Ampex stereo demonstration tape.

In our last issue I mentioned the meeting held to discuss the formation of a **Dover** club. The meeting met with success, and at the inaugural meeting on March 4 fifteen enthusiasts were present to see Mr. Whitmond of Simon Equipment Ltd. give a demonstration of the Simon SP 4. Following the natural enthusiasm of the demonstration, members made arrangements for a tour of the Simon factory in London.

Their following meeting, March 21, was intended to be a recording session of a local skiffle group. One of the "musicians" was indisposed and Mr. P. Burton hurriedly filled the gap with a talk on recording in general.

Members have organised a competition to select the best holiday recording made this year.

Club Secretary is Mr. G. Newey, 2, Westcliff Cottages, Westcliff, Nr. Dover.

Enthusiasts in **Wandsworth** and **Putney** will be interested to hear of the proposed formation of a club in that area. Denys Killick has the ambition and he can be contacted at 6, Disraeli Gardens, Fawe Park Road, Putney, S.W.15.

Mr. A. L. Masters, 21, The Grove, **Coulsdon**, Surrey, would like to hear from enthusiasts in his area. Mr. D. F. Lewis, 2, Keswick Road, Blaby, Leicestershire, who is shortly moving to live in **Nuneaton**, is keen to continue his past activities with the Leicester club, and would like to hear from persons interested in a Nuneaton club.

Mr. E. S. Price would like to hear from enthusiasts interested in forming a club in **Southend**. Contact him direct at 36, Chestnut Grove, Southend-on-Sea.

**The Family Circle**, tape exchange between family groups, is now in motion. Dennis Osborne, who with his wife, first suggested this idea, invites any interested families to write to him at 75, Millmead Road, California, Birmingham 32. At the moment he is on the look-out for a regular meeting place and would like to hear of any suitable premises.

Donald Rivers of "Woodeaves," 17, Hillcrest Road, Bramhall, Cheshire, is in touch, through the "Save the Children Fund," with a very poor Austrian family in Vienna. He would like to contact a tape enthusiast in that city, with the idea of relaying tapes to the family.

Next Sunday, April 10, F. C. Judd will be giving a lecture on tape recorders and decks at the monthly meeting of the East London Group of the Radio Society of Great Britain. The meeting starts at 3 p.m. in the Lambourne Room of the Ilford Town Hall.

## LONDON

### Lee Electronics

TAPE RECORDER & HI-FI AUDIO SPECIALISTS  
400, EDGWARE ROAD, LONDON, W.2

London's leading Stockists of High-Fidelity and Audio Equipment. Many Bargains in new and reconditioned Equipment.

SEND FOR FREE LISTS

All Machines demonstrated for performance on Record and Playback. All leading makes of Hi-Fi equipment from stock

PADDINGTON 5521



In this feature you can check your nearest dealer who is a hi-fi specialist giving expert attention to tape equipment.

## MIDLANDS

### TAPE RECORDERS

on "NO-INTEREST" Terms!

Buy your new Tape Recorder without touching CAPITAL! NO EXTRA CHARGES FOR EXTENDED CREDIT. You pay the Retail Price only. All leading makes stocked—Grundig, British Ferragraph, Philips, Vortexion, Telefunken, Baird, Walter, etc.

### JEWKES & CO. LTD.

The Midlands Hi-Fi and Tape Recorder Specialists  
285, BROAD STREET, BIRMINGHAM 1.  
MID 4829/20

### Hi-Fi Consultants and Dealers

STUDIO RECORDING AND  
DUBBING FACILITIES  
Studio A, 40 ft. x 40 ft.

TAPE TO DISC  
professional standards

### OLYMPIC SOUND STUDIOS

Carton Hall, Carton St., London, W.1  
Tel.: HUN 1635

Agents for SAGA Records and Tapes ★ Dealers in CQ Audio Equipment

### ALL TAPE RECORDERS

From the Specialists

### TAPE RECORDERS

(Bournemouth) LTD.

Main Area Dealers for

FI-CORD : PHILIPS : GRUNDIG

Authorised Service Agents for

### TELEFUNKEN & WALTER

(Southern England)

Tapes and Accessories by Return. Terms available on New or Reconditioned sets.

WRITE OR PHONE FOR FREE BROCHURE

Seamoor Road, Westbourne,

BOURNEMOUTH, Hants.

Telephone : Westbourne 64292

### R-E-S of COVENTRY

SPECIALISTS IN HIGH FIDELITY  
and all makes of Tape Recorders

- ★ Stocks of Stereophonic and Pre-Recorded Tapes
- ★ Demonstrations always available by fully qualified staff
- ★ The Best Selection—Terms or After Sales Service in the MIDLANDS

### R-E-S (COVENTRY) LTD.

128 FAR GOSFORD STREET  
Coventry 60913

# SPECIAL OFFER — Half-a-crown to find a ready buyer or a willing seller

**IF YOU HAVE SURPLUS EQUIPMENT YOU WISH TO SELL, OR IF YOU WANT TO BUY ITEMS SECOND-HAND, YOU WILL GET RESULTS BY USING OUR CLASSIFIED COLUMNS. TO PROVE THE POINT, WE ARE OFFERING READERS A SPECIAL RATE UNTIL APRIL 19th NEXT—2s. 6d. FOR UP TO TWENTY WORDS IF YOU USE THE FORM BELOW**

## Classified advertisements

Trade, ninepence per word (minimum 10s.); box numbers, one shilling extra. Payment with copy. Copy should be sent to Advertisement Department, "Tape Recording Magazine," 1, Crane Court, Fleet Street, London, E.C.4.

Hire the Grundig "Cub" Transistor Portable Recorder for your holiday—£3 3s. per week. BM/DNKD, London, W.C.1.

Grundig TK 8 with Microphone, perfect condition, "Best model they ever made," bargain at £50 o.n.o. Box 343, or phone Bourne End 474. Evenings.

**PERSONAL PROBLEMS?** Personality Difficulties? All psychological problems treated at home with individual tapes recorded by established psycho-therapist. Send for full particulars: Riverdale, Old Mill Lane, Cowley, Middlesex.

Bachelor, forties, own car, seeks companion (either sex) off-beaten-track inexpensive tour Germany, Prague, Austria, combining tape/colour photography. BM/MHMJ, London, W.C.1.

**CONVERSION PULLEYS FOR COLLARO TRANSCRIPTORS.** Substitute 1½ for 15 ips at 10s. per pulley. Howard Freer, 5, Romford Road, Coventry.

For Sale. Telefunken KL85K 6 watt output. Purchased 1959, £65. HOU 2489.

Maestrovox Tape Recorder—Collaro 3 speed deck with mic. Two years old, little used. Cost £65—accept £25. Phone ARNold 7963 (evenings).

For Sale. Winston Thoroughbred Recorder, in perfect working order. Offers to R. M. Vass, 19, Eastfield Road, Enfield, Middx.

For Sale. Valradio D.C./A.C. Vibrator Converter. Input 200/250 volts. Output 100/250 volts. 50 or 60 c/s. Cost £12 17s. 6d. Accept £5. Mr. G. A. Carter, 13, Sylvester Road, Hackney, E.8.

WAL . . . meet us at THE AUDIO FAIR from 21st to 24th April inclusive. Wellington Acoustic Laboratories Ltd., Farnham, Surrey.

Manager of Music Shop, thoroughly experienced tape recorders and records. Requires post, London or South. Box 341.

Save £16. Philips Tape Recorder, Model EL3527. New, full guarantee. Cost £41. Accept £25. Hatherley, 134, Uxbridge Road, London, W.12.

WANTED. Second hand AM/FM pre amp., also time switch. Good price paid. Richards, 36, Tuckers Road, Loughborough, Leics.

Complete unit. Leak P.U. T.L. 12 plus Varislope III, T.L. Tuner, Trans. Tape deck and Gramtable. Modern Console. Three-way Goodmans corner reflex £115. Erith 36004.

WANTED. Barrel Organ Music. Preferably on tape. Replay speed 3¼ or 7½ ips. Private advertiser. Box 342.

WAL GAIN transistor pre-amplifier £5. WAL GAIN STEREO Transistor pre-amp. £7 10s. WAL BULK TAPE ERASER, cleans a reel in 30 secs., £7 18s. 6d. Ask your dealer for details, or send to us for full descriptive leaflets. Wellington Acoustic Laboratories Ltd., Farnham, Surrey. (6461 or 4961.)

Grundig TK 20, Mic., Extension Lead. Perfect condition, bargain £38 o.n.o. Broadbent, 47, Elmstead Gardens, Worcester Park, Surrey. Derwent 1790.

Repairs to all makes! Estimates free! Efficient, reasonably priced servicing by the people who know Tape Recorders. HOWARD PHOTOGRAPHIC, 218, High Street, Bromley, Kent. Ravensbourne 4477.

Tape recorders, players, radios, etc. (modern) wanted for cash. Callers or particulars Cooks Store, 159-187, Praed Street, W.2. (opposite Paddington Station). Tel.: PAD 6464.

JOHN HASSELL RECORDINGS. Tape/Disc. All speeds. CCIR Studio. 21, Nassau Road, London, S.W.13. Riverside 7150.

**SPECIAL OFFER! SAVE 11 GNS.!** Stella—Philips Tape Recorder, 3 speeds with moving coil mike. List 63 gns. OUR PRICE 52 gns. or Terms. E. C. Kingsley & Co., 132, Tottenham Court Road (Corner Warren Street) London, W.1. EUSon 6500.

One-Tenth Deposit—Three Years to Pay! All makes stocked, let us quote you. Simmon of Halifax. Paul Simmon, 35, Northgate, Halifax.

TAPE RECORDER need repairing? Let the specialists do it for you at an economical price. See page 26. ESSEX TAPE RECORDER CENTRES.

FRIENDLY FOLK ASSOCIATION, 87, Terrace, Torquay. Leading International Correspondence Hobby Club since 1943. Now included, facilities for Tapesponding. Details free.

Tape Recorders. Large selection of used models mostly as new with Three Months Guarantee. Part exchange with cameras, binoculars, etc. Good quality recording tape on spools—3 in., 7s.; 4 in., 8s. 6d.; 5½ in., 19s. 6d. and 25s.; 7 in., 25s. Cooks Store, 159-187, Praed Street, W.2 (opposite Paddington Station). PAD 6464.

Ferrograph early series 3 AN. 7½, 3¼ ips. Immaculate, best offer over 55 gns. Also Simon Cadenza Mic., best offer over 6 gns. S. R. Church, 42, Langley Park Road, Sutton, Surrey.

Grundig TK30 Tape Recorder and GDM111 microphone. As new condition. Will sell for £63. Defreston, 125, Fellows Road, London, N.W.3.

Sound A.20. Excellent condition, complete with tapes, microphone leads. Sell for nearest offer £35. Weekdays after 7.30 p.m. telephone UPLands 5512.

## CLASSIFIED ADVERT — SPECIAL OFFER

*I enclose postal order for 2s. 6d. Please insert as follows*

Name ..... Address .....

Trade announcements not included. Box number extra



# We have customers in . . .

Leicester, West Drayton, Lewisham and Preston; Chichester, Sheffield, Bristol and Grimsby; Edinburgh, Carlisle, Plymouth and Leeds; East Grinstead, Ebbw Vale, Hitchin and Southall; Orpington, York, Bridgewater and Ventnor; Dulwich, Hanley, Redhill and Burntoak; Rugeley, Biggin Hill, Leigh-on-Sea and Salisbury; Brentwood, Purley, Ashton-under-Lyne and West Hartlepool; West Wickham, Innerleithen, Ilford and Aintree; Sanderstead, Gorleston-on-Sea, Liverpool and Middlesbrough; Nottingham, Bexleyheath, Croydon, Tredegar, Dalton in

Furness, Thetford, Rainham and Bradford; Leamington Spa, Cheltenham, Loughton and Birchington; Spilsby, Chorley, Derby and Barnsley; Alford, Chessington, Woodford Bridge and Sevenoaks; Feltham, Southampton, Kendal and Tonbridge; St. Helens, Doncaster, Watford and Bromley; Richmond, Cheadle, Corby and Warlingham; Bexhill, Hemel Hempstead, Sydenham and Bromsgrove; Arborfield, Gravesend, New Ferry and Beckenham; Canada, Australia, Ceylon and Hong Kong!

WHY NOT WRITE FOR DETAILS NOW  
OF OUR RANGE OF TAPE RECORDERS

## TAPE RECORDER SERVICE CO.

95 Beckenham Lane, Shortlands, Bromley, Kent.

RAVensbourne 6119

CUT ALONG DOTTED LINE

## ADVERTISEMENT ENQUIRIES SERVICE

*This is a special service for readers of TAPE RECORDING AND HI-FI MAGAZINE. It enables you—without cost—to get fuller information about those products in which you are particularly interested. Fill in one coupon below for each inquiry, writing in your name and address in each case. Then cut out the whole of this half-page, following the dotted line, fold as indicated, and post to us.*

<p>I should like further information about the..... ..... (product) mentioned on page.....of the ..... issue of <i>Tape Recording and Hi-Fi Magazine</i>.</p> <p>NAME .....</p> <p>ADDRESS..... ..... .....</p> <p>April 6th, 1960</p>	<p>I should like further information about the..... ..... (product) mentioned on page.....of the ..... issue of <i>Tape Recording and Hi-Fi Magazine</i>.</p> <p>NAME .....</p> <p>ADDRESS..... ..... .....</p> <p>April 6th, 1960</p>	<p>I should like further information about the..... ..... (product) mentioned on page.....of the ..... issue of <i>Tape Recording and Hi-Fi Magazine</i>.</p> <p>NAME .....</p> <p>ADDRESS..... ..... .....</p> <p>April 6th, 1960</p>
--	--	--

# Grundig TM60

(Continued from page 21)

Additional tests included recording tones of various frequencies and then checking the recording for intermodulation. The through test showed that intermodulation is extremely low and a square wave test (1,000 cps) showed that harmonic loss through the recording process is also quite small. I have yet to find a tape recorder that will record and playback a squarewave, even as low as 1,000 cps, without distortion.

A frequency response test was made at 3½ ips and the curve of Fig. 1 shows this to be substantially level to 8,000 cycles, which was the limit of the test tape for this speed.

## MANUFACTURER'S SPECIFICATION

Mains voltage, suitable for AC only 110-125, 190-210, 210-230, 230-250 volts —50 cps.

Consumption, approximately 85 watts. Valves, 2 x EF86 — 2 x ECC81 — 2 x EL95, EM 84, plus 4 metal rectifiers.

Tape speeds, 7½ and 3½ ips. Frequency response, at 7½ ips, 50-15,000 cps ± 3 dB; At 3½ ips, 50-10,000 cps ± 3 dB.

Recording sense, monophonic—Top track, left to right (International standard).

Recording Time (per tape, using 1,800 ft. L.P. tape), 45 minutes at 7½ ips (stereo) and 1½ hours at 7½ ips (mono).

Signal to noise ratio, better than 40 dB.

I can only conclude by saying that a lot more could be written about the excellent qualities of the TM60. Anyone contemplating stereophonic and monophonic recording at its best should seriously consider this machine. Having had the opportunity of studying its mechanism and electronics and of testing very thoroughly the performance, I have no reason to doubt that it called for both careful design and considerable development work to produce such a first-class instrument. I do not hesitate for one moment to recommend it as the nucleus of a very complete fidelity stereo recording outfit.

Wow and flutter, less than 0.2 per cent at 7½ ips. Less than 0.25 per cent at 3½ ips.

Fast re-wind time, approx. 2½ minutes (depending on length of tape).

Automatic stop switch, at ends of tape (metalized foil).

Superimposition (mono only), to superimpose a second recording on to a previously recorded tape.

Inputs, microphone (2.5mV/1.5M.ohm); Diode/Gram (2mV/39K.ohm).

Output, Left-hand channel and mono, 400mV/4.7K.ohm. Right-hand channel, 400mV/4.7K.ohm.

Dimensions, 12 x 14½ x 8½ in. Weight, 25 pounds.

## Index to Advertisers

	page
A. L. Stamford .....	35
Audio Devices Ltd. ....	36
Deroy Sound Service .....	24
E.A.P. (Tape Recorders) Ltd. Front Cover	
E.M.I. Sales and Service Ltd. ....	2
Essex Tape Recorder Centres .....	26
Francis of Streatham .....	6
Garrard Engineering Co. Ltd. ....	5
Henri Selmer & Co. Ltd. ....	8
Howard Photographic .....	30
Jewkes & Co. Ltd. ....	31
Lee Electronics Ltd. ....	31
Lustraphone Ltd. ....	6
Magnegraph .....	24
Metro-Sound Manufacturing Co. Ltd.	30
Multicore Solders Ltd. ....	35
Norwich Union .....	28
Olympic Sound Studios .....	31
Psycho-Tape Institute .....	6
Radiostructor .....	28
Rapid Recording Service .....	24
R.B. Tapes Co. Ltd. ....	28
R.E.S. (Coventry) Ltd. ....	31
R.E.W. Earlsfield Ltd. ....	8
Simon Equipment Ltd. ....	7
Sunderland Sound Services .....	24
Swains Papercraft .....	30
Tape Recorders (Bournemouth) Ltd.	31
Tape Recorder Service Co. ....	33
Technical Suppliers Ltd. ....	35
The Recorder Co. ....	35
The Tape Recorder Centre .....	3
Welmec Corporation Ltd. ....	9
Wilmex Ltd. ....	4
Wyndors Recording Co. Ltd. ....	10

CUT ALONG DOTTED LINE

**POSTAGE WILL BE PAID BY PRINT AND PRESS SERVICES LIMITED**

**BUSINESS REPLY FOLDER**  
Licence No. ND 922

**TAPE RECORDING & HI-FI MAGAZINE,**  
ADVERTISEMENT ENQUIRIES,  
7, TUDOR STREET,  
LONDON, E.C.4.

THIRD FOLD HERE

SECOND FOLD HERE

FLAP A

NO POSTAGE STAMP NECESSARY IF POSTED IN GREAT BRITAIN OR NORTHERN IRELAND

FLAP B

FIRST FOLD ALONG THIS LINE

**TO OBTAIN DETAILS OF ADVERTISERS** →

Make sure your name and address etc., is clearly shown on the form overleaf.

Cut along the dotted lines.

Fold along lines as indicated and then tuck Flap A into Flap B.

April 6th, 1960

# **Bib** RECORDING TAPE SPLICER

**FOR EASIER AND ECONOMICAL TAPE EDITING**

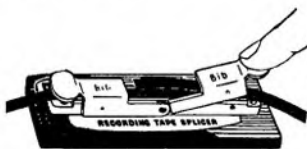

The easy-to-lift clamps on the new Mark II Bib Recording Tape Splicer are both hinged on the same side of the splicer, making the jointed tapes easy to remove. Precise, rapid tape jointing is ensured, and because you can use all the odd lengths of tape, you soon save the cost of the splicer.

Everyone who uses a tape recorder will need this little tool. It is indispensable. P. Wilson. "The Gramophone."

Send a stamped addressed envelope for a helpful leaflet on tape editing.

**18/6 each (subject)**

If you have difficulty obtaining a Bib splicer, let us know the name and address of your dealer.

Multicore Solders Ltd., Multicore Works, Hemel Hempstead, Herts. Tel: Boxmoor 3636

## Cabinets, enclosures and equipment by Stamford

TUNERS	Cash Price		Hire Purchase Deposit 18 Months		EQUIPMENT CABINET 3ft. wide, 35in. x 14in. Motor Board, 35in. x 13in. Control Panel or portion for tape storage.
	£	s. d.	s. d.	s. d.	
Dulci FM Powered...	16	13 11	50	3 18 2	
Rogers FM .....	24	10 3	73	6 26 7	
Armstrong FM61 ....	25	18 0	77	0 28 2	
AMPLIFIERS					
Quad II and Control.	42	0 0	126	0 45 9	
Rogers Junior .....	28	0 0	84	0 30 6	
Leak Stereo 20 .....	51	9 0	155	0 55 11	
MOTORS					
Garrard 4HF .....	18	9 9	55	6 20 1	
Collaro 4T/200 .....	18	13 0	54	9 20 4	
SPEAKERS					
Axiom 110 .....	5	0 0	15	0 5 5	
Axiom 300 .....	11	5 9	34	0 12 3	
WB HF1012 .....	4	15 0	14	3 5 2	
10in. Golden FSB ...	8	6 7	25	0 9 0	

Price £16 16s. or Deposit 51s. and nine monthly Payments of 34s. Choice of finishes.

**A. L. STAMFORD, LTD.** (Dept. L.3)  
84/86/98, Weymouth Terrace, Hackney Rd., London, E.2

## THIS or THIS?



Grundig TK 30

The best way to choose is to have a full demonstration. In other words come to The Telefunken 75K-15 Recorder Co. and see the whole range of Tape Recorders available, side by side, so that you can

Telefunken 75K-15

Recorder Co.

appreciate the merits of one against the other in open competition. The price range of Recorders offered is from £25 to £155. If you live too far to call, our mail-order department is at your service.

- ★ We are mail-order specialists—free catalogues and full information on request.
- ★ Free Insurance Policy covering your payments in the event of sickness, accident or unemployment, etc.
- ★ Open all day Saturday. Fridays until 6-30 p.m.
- ★ INTEREST FREE H.P. TERMS.

## **THE RECORDER CO.**

(Dept. T) 188, West End Lane,  
WEST HAMPSTEAD, LONDON, N.W.6

'phone : SW1 4977

# At the AUDIO FAIR T S L will be showing the following fine equipment

**HARTING**

**ELEKTRON**

**KORTING**

*4-Track Stereo Mono Recorders*

**TSL "VEDETTE"**

*2-Speed Recorder*

**TIMBRA**

*Professional Recorder*

**TSL MICROPHONES**

**TSL-LORENZ SPEAKERS**

**ORTOFON PICK-UPS**

*(STEREO & MONO)*

**THORENS TRANSCRIPTION**

**MOTORS**

*Pre-recorded Tapes*

*(STEREO & MONO)*

*and other important equipment*

**BOOTH**

**No. 48**

**DEM. ROOM**

**No. 247**

Leaflets gladly sent on request if you cannot visit us at the Audio Fair

## **TECHNICAL SUPPLIERS LTD.**

HUDSON HOUSE, 63, GOLDHAWK RD., LONDON, W.12

Telephone—SHEpherds 2581 and 4794

SUPPLIERS OF FINE EQUIPMENT TO THE TRADE

# Sensational success of audiotape

TRADE MARK

Tape Recording experts and enthusiasts all over the country are changing to AUDIOTAPE for its flawless perfection of sound reproduction over the entire audio range and its *consistent, uniform quality* from reel to reel.

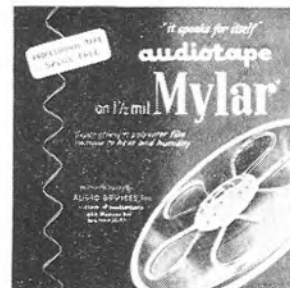

Available on all standard reel sizes, there are eight different types to meet every recording requirement. AUDIOTAPE, manufactured in the U.S.A., by Audio Devices Inc., gives you the truest sound your recording equipment can produce—try AUDIOTAPE . . . it speaks for itself.



## Sensational C-SLOT REEL!

All 5" and 7" reels of AUDIOTAPE are supplied on the exclusive C-Slot Reel—the fastest-threading tape reel ever developed. The tape end, dropped into a slot in the hub, anchors itself automatically at the first turn of the reel.

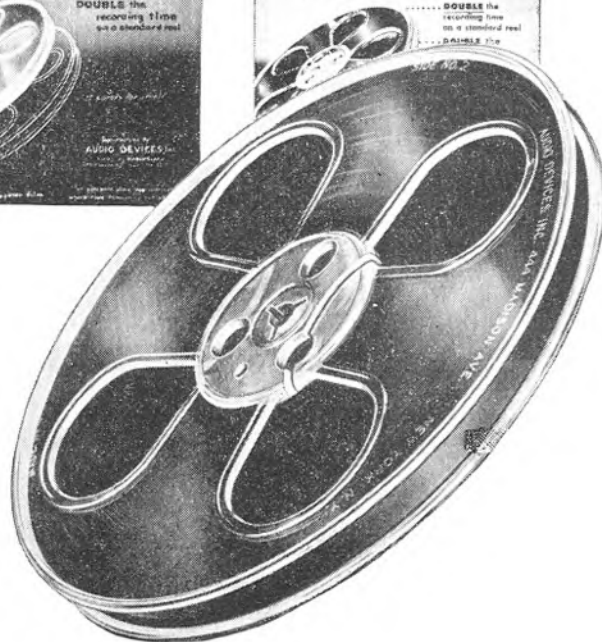

**ELPICO** A NAME FOR BETTER PERFORMANCE

Concessionaires to the United Kingdom and Eire

**LEE PRODUCTS (Gt. Britain) LIMITED**  
ELPICO HOUSE, LONGFORD STREET, LONDON, N.W. 1

Telephone: EUSton 5754 (all lines) Telegrams: Leprod, London.

**BIG AUDIO  
FAIR NEWS**  
10 page supplement

# TAPE

RECORDING  
AND HI-FI MAGAZINE

in Room 115

## 'The Magic Tape'

a **BASF** presentation

- \* 1st prize at 1959 Berlin International Festival of Industrial Documentary Films
- \* 3 special awards — Best Production — Best Camerawork — Best Commentary
- \* Also awarded an 'Oscar' at 1959 Rouen International Festival of Industrial Documentary Films

1st among more than 80 films entered, 'The Magic Tape' highlights in 30 minutes of fascinating colour and action what can be achieved with magnetic recording tape.

It provides the perfect background to the 'Authentic Sound' story of BASF tape — so excitingly told in many other ways on STAND No. 2.

London Audio Fair  
Hotel Russell  
April 21-24



for **Authentic Sound**

F. A. Hughes & Co. Ltd 4 Stanhope Gate London W1

*FIRST AND FOREMOST IN THIS FIELD*

FORTNIGHTLY **1/6**  
20th April, 1960

YOU GET *Vivid* REALISM...

...with the  
wonderful



# HMV TAPE RECORDER

Speech, music, sound effects . . . you get VIVID REALISM every time with this fine tape recorder. This isn't surprising when you consider its many 'professional' features. What is surprising is that such a quality machine should be so modestly priced. Hear it at your dealer's and you'll realize that "His Master's Voice" offers TODAY'S FINEST TAPE RECORDER VALUE!

- \* Two speeds:  $7\frac{1}{2}$  i/s and  $3\frac{1}{2}$  i/s
- \* Frequency response: 50-10,000 c/s at  $7\frac{1}{2}$  i/s  $\pm$  3dB
- \* Takes 7" spools
- \* Half-track operation
- \* Three-motor drive
- \* Separate record and playback amplifiers
- \* Three head system for instantaneous playback
- \* Pause control for instantaneous stop/start



**ONLY £50**

Complete with 1,200' Emitape, spare spool and crystal microphone.



THE GRAMOPHONE COMPANY LIMITED · HAYES · MIDDLESEX

# IS HALF YOUR TAPE RECORDER

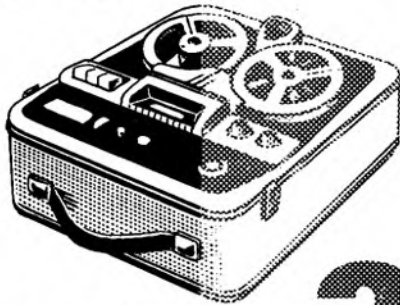

## WASTED?

The performance of a portable tape recorder is severely limited by the space available for its internal loudspeaker.

The connection of a high quality external speaker will reveal hidden detail in your recordings, and the Wharfedale PST/8 is an ideal choice.

This unique, patented enclosure design gives optimum results with Wharfedale 8" foam surround units which are available in a range of impedances to suit all machines.

*Descriptive literature sent FREE on request*

## WHARFEDALE PST/8

PRICES CABINET ONLY  
£7 10s. 0d. in whitewood  
£10 10s. 0d. finished in  
walnut, oak or mahogany  
veneers.

Recommended units 8" Bronze/FS/AL £4 6s. 7d. inc. P.T.  
Super 8FS/AL £6 19s. 11d. inc. P.T.

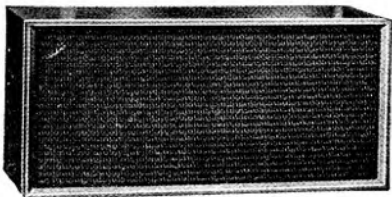

Tel: Idle 1235/6

Grams:  
'Wharfedel' Idle  
Bradford

**Wharfedale**  
WIRELESS WORKS LTD  
IDLE BRADFORD YORKS

# Pops for pennies

## FOR YOU!

How would you like to be able to collect *all* the 'pops' you want? *Every single one* for only a fraction of the normal cost!

You can, you know—with a Grundig Tape Recorder. Just think; any music you like and as much as you like. On tapes that will never wear out and yet can

be changed as often as you wish.

There simply isn't room here to tell how easy and inexpensive it is to own a Grundig or of the thousands of ways in which these wonderful tape recorders can give you pleasure but your local Grundig Approved Dealer will be delighted to tell you the rest. Go and see him as soon as you can.



**GET A  
GRUNDIG**

GRUNDIG (Great Britain) LTD. 39/41 New Oxford Street, London, W.C.1.  
G5221C

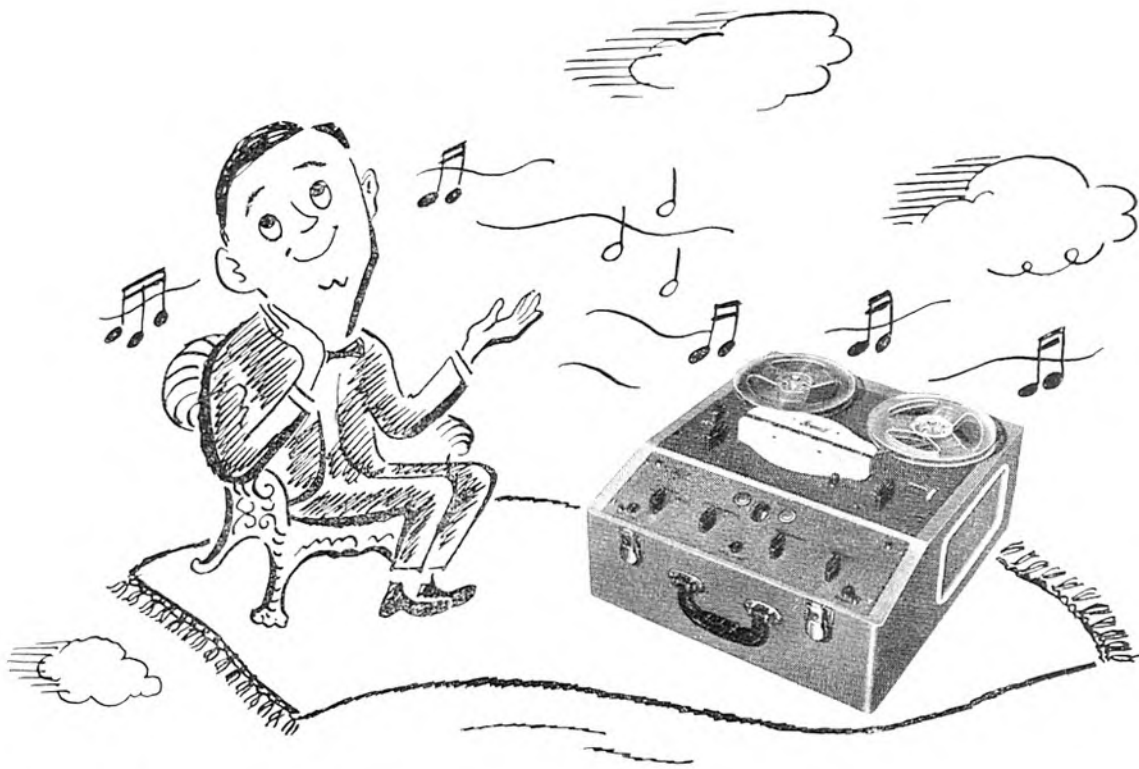

## You'll be carried away

*with the true-to-life performance  
of the latest **Brenell** models —*

3 star 3 speed portable tape recorder	58 gns
3 star record/playback stereo model	89 gns
or with two microphones	95 gns
Mk.5 4 speed tape deck	28 gns
Mk.5 4 speed complete recorder	64 gns
Mk.5 record/playback stereo model	£93.16.0

*See and hear them at the  
**AUDIO FAIR***

Hotel Russell . April 21st—24th

<b>STAND</b>	<b>DEMONSTRATION</b>
No. <b>8</b>	ROOM <b>117</b>



*Sole Manufacturers*

**BRENELL ENGINEERING CO., LTD. 1A DOUGHTY STREET, LONDON, W.C.2 HOL: 7358 & CHA 5809**



# Chitnis

## 4 & 2 TRACK TWO SPEED RECORDERS



Mixing facilities, better arrangement of controls; powerful silent running motor by Papst and a really smartly styled lockable case make owning a Chitnis Recorder really worth while; and the four-track model halves tape cost and storage problems. The Bogen heads fitted ensure genuine hi-fi performance at  $3\frac{3}{4}$  ips. giving a response from 30-16,000 c/s  $\pm$  3 dB. Signal-noise ratio is better than 55 dB unweighted. Speeds  $3\frac{3}{4}$  and  $1\frac{1}{2}$  ips. Chitnis Recorders are robustly built, easily carried and as suitable for professional use as for the family.

**KM.22**

TWO TRACK

**54 gns.**

**KM.33**

FOUR TRACK

**62 gns.**

*Complete with Chitnis  
Dynamic Microphone  
M.50T. and Tape.*

### STEREO MODELS

Chitnis 2-speed 4 and 2 track recorders complete with two speakers (one in lid) will be showing at the Audio Fair. Leaflet gladly sent on request.

**WE ARE SHOWING  
AT THE AUDIO FAIR**

Booth 11 and Demonstration Room 134

Leaflets on request from

**Chitnis Electronics Ltd.**

**1, LONG ACRE, LONDON, W.C.2**

Phone: COV 2052

# FREE

## fun for families!

Once you own a Grundig Tape Recorder and a spool of tape the fun is free! First class entertainment, wonderful music, exciting drama,

sporting events: everything—for nothing. And there's nothing else you need to buy.

And think of all the family pleasures. Think of the fun you could have with your friends; and how wonderful it would be to record their voices and play them back. Or keep them as treasured memories for as long as a lifetime.

It isn't possible in one advertisement to tell you all the wonderful things you can do with a Grundig. Why not visit your local Grundig Approved Dealer and get him to give you a demonstration.



## GET A

# GRUNDIG

**GRUNDIG (Great Britain) LTD.** 39/41 New Oxford Street, London W.C.1  
G3 226C

The latest and best from the Audio Fair  
now at the

# TAPE RECORDER CENTRE

All the very latest and best Tape Recorders and Hi-Fi Equipments shown at this year's Audio Fair are now available from the Tape Recorder Centre. Come in person to see, hear and compare all makes, or send for the unique free Catalogue—the most comprehensive and up-to-date in the country.

- ✱ **NO-INTEREST TERMS**  
on all orders over £30
- ✱ **FREE ILLUSTRATED 72-PAGE CATALOGUE**  
the most detailed publication of its kind
- ✱ **HUGE STOCKS OF ALL MAKES**  
ensuring quick delivery to all parts of the country
- ✱ **HONEST, INFORMED ADVICE**  
from enthusiastic tape-recording and Hi-Fi specialists
- ✱ **COMPREHENSIVE MAINTENANCE SERVICE**  
and inexpensive maintenance contract if desired

**Tape Recorders**

Grundig  
Elizabethan  
Ferrograph  
Vortexion  
Walter  
Brenell  
Reflectograph  
Simon  
Harting  
Telefunken  
Philips  
Spectone  
Verdik  
Veritone  
Stuzzi-Magnette  
Fi-cord  
Truvox  
Kurland  
Reps  
Wyndson  
Regentone  
Perth-Saja  
Elektron  
Minivox  
Korting

**Hi-Fi Equipment Microphones, Speakers, etc.**

Leak  
Quad  
Rogers  
Armstrong  
Jason  
Dulci  
Pamphonic  
Stentorian  
Avantic  
Pilot  
Collaro  
Elpico  
Decca  
Philips  
Wright & Weaire  
G.E.C.  
Goodmans  
C.Q.  
Wharfedale  
Elac  
B.J.  
Garrard  
Connoisseur  
Goldring  
T.S.L.  
Stirling Tuners

**Tape**

Emitape  
Scotch Boy  
BASF  
Grundig  
Telefunken  
Elpico  
Soundrite  
Gevaert  
Philips  
Agfa  
*All Accessories,  
Tapes, etc., by  
return of post.  
All makes in stock.*

You can choose with confidence from the leading Specialists :

## THE TAPE RECORDER CENTRE

For free Catalogue send this coupon to: The Tape Recorder Centre Ltd.,  
Dept. T, 75 Grand Parade, Green Lanes, Harringay, London, N.4.

STAmford Hill 1146

NAME ..... ADDRESS .....  
..... (BLOCK LETTERS PLEASE)



# AKG

★ ★ ★ ★ ★ ★ ★ ★ ★ ★

*in the service  
of sound*

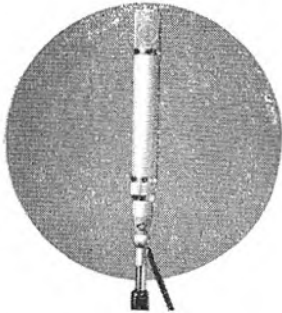

World-famous AKG microphones cover a range to meet the needs of those who use tape recorders at home to those whose work is with the world's giant broadcasting, television, film and recording organisations. Models D.11/N and D.9 (Mono) and D.88 (Stereo) are particularly recommended for private as well as professional users.

### C.12

Condenser microphone for highest professional requirements. Its pattern may be varied at will during actual use.

### D.88 STEREO

High-quality double cardioid microphone unit for stereo recording. Can also be used as a wide angle mono instrument. Frequency range 60-15,000 c/s.

### D.11/N

An entirely new dynamic microphone for use specially with domestic tape recorders. Cardioid pattern. Frequency range 80-15,000 c/s. 180° discrimination. Sound incidence ratio (front to back) 15 dB. Maintains working conditions over range from -30° to +70°c. In elegantly styled case. High or low imp.

### D.9

Dynamic general purpose microphone of robust design and excellent performance characteristics well suited to tape requirements.

*Details of AKG Microphones gladly sent on request.*

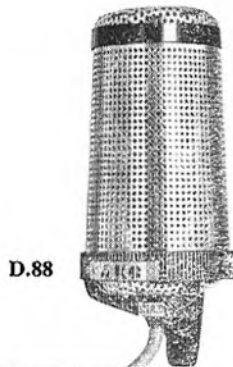

D.88

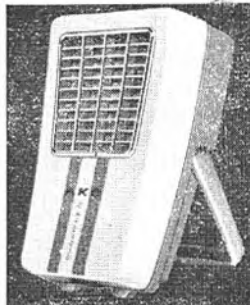

D.11/3



**AT THE AUDIO FAIR**

BOOTH  
34

DEM. ROOM  
312

Sole Agents for U.K. and Commonwealth

**POLITECHNA (LONDON) LTD.**

3, Percy Street, London, W.1 LAngham 6236-7-8

★ ★

# MUSIC MUSIC MUSIC

Music—once you own a Grundig Tape Recorder—is as free as the air. At the touch of a switch you can record, for your private enjoyment, the pick of the world's best; any music you like. It will never 'wear out'—you can play a recorded tape for a lifetime—but if you tire of a tune you can change it without cost. All you need do is to record a fresh tune over the unwanted one *on the same tape.*

Dance music, pops, skiffle, 'rock'; whatever you like, whenever you like—that's what owning a Grundig means. It means so much else, too. More than could possibly be described in one advertisement. Why not ask your local Grundig Approved Dealer for all the details—and a demonstration.



**GET A**

**GRUNDIG**

GRUNDIG (Great Britain) Ltd. 39/41 New Oxford Street, London W.C.1 GS222D

# A REVOLUTIONARY NEW BRITISH INVENTION!

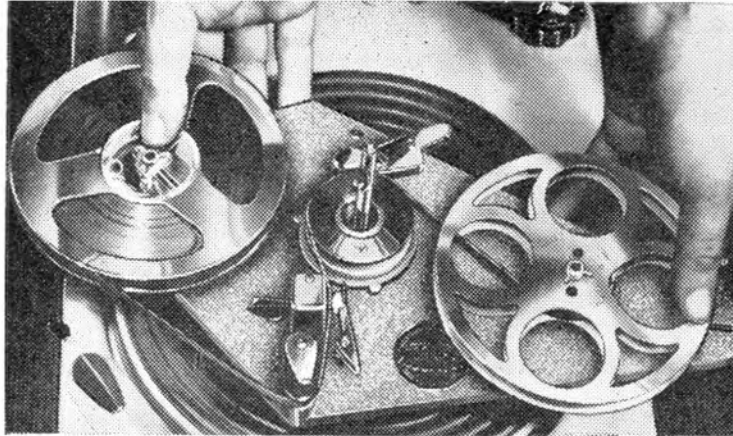

## Gramdeck

GRAMOPHONE TAPE RECORDER

- Instantly turns your gramophone into a first-class Tape-Recorder.
- As easy as putting on a record. Slip it on—it's a tape-recorder! Lift it off—it's a record-player!
- Records direct from radio or microphone.
- Plays back at the flick of a switch through gramophone or radio.

**COMPLETE—READY TO RECORD  
OR PLAY BACK!**  
**£13.12s** EASY TERMS  
CASH AVAILABLE

**ALL THE ADVANTAGES OF A TAPE RECORDER  
FROM YOUR RECORD-PLAYER OR RADIOGRAM  
—AT LITTLE EXTRA COST**

*"Lifelike  
realism"*



SAYS

**TED  
HEATH**

*"Far better than anything  
I have heard for a long time"*

- ★ Plays at 7½" per sec. Other speeds if desired.
- ★ Uses standard single or double-track tape.
- ★ Erase head. Fast motor rewind or hand rewind.
- ★ Instantly plays back through gramophone or radio.
- ★ Enables you to record out-doors too!
- ★ Tone as good as you get from your radio or gramophone.

"Ingenious—simple . . . why on earth did no one think of it before!"—*The Tape Recorder.*

"Ingenious and robust."—*British Sound Recording Association Journal.*

"Quality of reproduction excellent . . . real hi-fi results . . . potential is tremendous . . . both designer and manufacturer should be congratulated."—*British Radio & T/V Retailer's Review.*

"Better than many so-called hi-fi recorders! . . . robust . . . carefully designed . . . excellent value."—*Amateur Cine World.*

MADE BY THE FIRM THAT MAKES  
MICROWAVE WAVE-GUIDES FOR  
VISCOUNTS & BRITANNIAS

**Gramdeck**  
GRAMOPHONE TAPE RECORDER

**Free!**



**FREE BOOK—POST NOW!**

I would like to know how to turn my gramophone into a first-class tape-recorder . . . please send me the Gramdeck Book—FREE and without obligation. (Write if you prefer not to cut coupon).

NAME .....

ADDRESS .....

GRAMDECK (Dept. TP/802) 29 WRIGHT'S  
LANE, KENSINGTON, LONDON, W8.

**GRAMDECK TURNS A TURNTABLE INTO A TAPE-RECORDER**



**I like the look of it—  
a really nice piece of furniture for  
the home—look at that lovely sapele  
mahogany—so easy to use too—those  
magazines—simple as putting on a record**



**I like its entertainment  
value—my favourite  
programmes, music,  
recordings of the kids—I can  
keep them—enjoy them when  
I like.**



**I like the inside—not that  
I'm allowed to touch it—  
the amplifier's got a triode  
push-pull output and there's  
full control for treble and bass.**



**A magazine full of the  
latest pops—it's just right for  
parties and for dancing.  
The built-in microphone is  
great when the gang comes  
round—you just talk at  
it and it records.**

## for all the family



## the Simon **Minstrelle** tape recorder

WITH MAGAZINE LOADING

Everyone likes the Minstrelle—and that's the way it should be, because it's the first tape recorder to be specially designed with the whole family in mind. Designer Peter Bell was commissioned to style a recorder as a piece of furniture that would fit with distinction into the home—and here's the brilliant result. Using tape magazines which you put on like

records—no threading or fuss—all the family can use it—even the young and not-so-mechanically-minded members. And inside that handsome cabinet there's a piece of electrical design and workmanship that you can be really proud of—built to ensure that you too, will "Choose Simon for Sound".

Price with the built-in microphone **39** gns. Easy Terms available.

At your local dealer or write to: SIMON EQUIPMENT LTD., 46/50 George Street, Portman Square, London W.1

# FREE H.P!

- ★ NO INTEREST CHARGES ★
- ★ 1/- IN £ DEPOSIT ★
- ★ 2 YEARS TO PAY ★



**We have the Biggest Sales in Gt. Britain.  
Why? Because we give the Best Terms!**

SPECIAL FREE TAPE OFFERS ★ FREE DELIVERY ANYWHERE IN U.K. ★  
FREE SERVICING FOR 12 MONTHS ★ NO P/TAX ★ PART-EXCHANGES &  
SECOND-HAND MACHINES ★ 250 machines, 40 models in stock ★ Mail Order  
Department covers the whole country ★ Open all day Saturday ★ Main Agents for  
all the best makes ★ Write, 'phone or call NOW for free brochures and full details of all our items:

# HOWARD

## PHOTOGRAPHIC

218 HIGH ST · BROMLEY · KENT · RAV 4477

## We have customers in . . .

Leicester, West Drayton, Lewisham and Preston; Chichester, Sheffield, Bristol and Grimsby; Edinburgh, Carlisle, Plymouth and Leeds; East Grinstead, Ebbw Vale, Hitchin and Southall; Orpington, York, Bridgewater and Ventnor; Dulwich, Hanley, Redhill and Burntoak; Rugeley, Biggin Hill, Leigh-on-Sea and Salisbury; Brentwood, Purley, Ashton-under-Lyne and West Hartlepool; West Wickham, Innerleithen, Ilford and Aintree; Sanderstead, Gorleston-on-Sea, Liverpool and Middlesbrough; Nottingham, Bexleyheath, Croydon, Tredegar, Dalton in

Furness, Thetford, Rainham and Bradford; Leamington Spa, Cheltenham, Loughton and Birchington; Spilsby, Chorley, Derby and Barnsley; Alford, Chessington, Woodford Bridge and Sevenoaks; Feltham, Southampton, Kendal and Tonbridge; St. Helens, Doncaster, Watford and Bromley; Richmond, Cheadle, Corby and Warlingham; Bexhill, Hemel Hempstead, Sydenham and Bromsgrove; Arborfield, Gravesend, New Ferry and Beckenham; Canada, Australia, Ceylon and Hong Kong!

WHY NOT WRITE FOR DETAILS NOW  
OF OUR RANGE OF TAPE RECORDERS

### TAPE RECORDER SERVICE CO.

95 Beckenham Lane, Shortlands, Bromley, Kent.

RAVensbourne 6119

# DON'T CUT THE TOP OFF



A tape recorder is only as good as its microphone.  
If you cut a top note off in the mike, you can't  
blame the recorder if the note isn't there.  
If there's distortion at the start, there'll be  
a din in the end. Give your recorder a fair chance.  
Give it a balanced, wide-frequency input. Give it  
a good microphone. Give it an Acos microphone.

USE  
AN  
ACOS  
MICROPHONE



## MIC 39

A crystal hand microphone of exceptionally attractive appearance. Extended frequency response; noise-free cable and die-cast liner to minimise hum and ensure excellent signal-to-noise ratio. Available with table-stands and floor stand adaptor. U.K. Retail price 3 gns. Other Acos microphones include the famous fold-away MIC 40 (35/-) the MIC 28 Lapel Microphone (50/-) and a superb new stereo microphone (£6.0.0)

*Acos microphones are standard equipment with most British high-quality tape recorders.*

**acos** ARE *also* **DOING THINGS IN STYLE**

COSMOCORD LTD WALTHAM CROSS HERTS · TEL: WALTHAM CROSS 25206 (London subscribers please dial WS 25206)



# the **FINEST TAPE RECORDERS** on **INTEREST FREE TERMS . . . .**

Write, Phone or Call today. You can buy by post with perfect confidence  
Deposits from 10 per cent, 12 months to pay

I know how difficult it is to choose the Tape Recorder. That is why more and more people come to the Royal Opera Arcade, because my advice, personal attention, and help are freely given. Full demonstrations at any time and you can always examine and hear the latest and most interesting machines. Remember—I am here to help you.

LAURENCE DICKINSON



Leaflets gladly sent if you are unable to call

## **NEW!** 4-Track Monaural Recorders

**PHILIPS 59 gns. TELEFUNKEN 64 gns.**  
**4-Track Stereo/Monaural Recorders**  
**PHILIPS 92 gns. HARTING 86 gns.**  
**KORTING 68 gns.**

**SERVICING.** We undertake rapid and efficient servicing of all Tape Recorders.

**TAPES.** Audio, Agfa, B.A.S.F., E.M.I., Geloso, Scotch Boy, Telefunken, etc. Send for lists.

**CAMERAS.** By Zeiss, Agfa, Eumig, Voigtlander, etc. Send for lists.

**READ** the all-in-one Tape Recorder Book, 12s. 6d. Packed with information.

**TELEFUNKEN DA CAPO RADIO,** 39 gns. Call and hear this fine instrument.

**TELEFUNKEN TAPE DECK,** 63 gns. Use it with your amplifier or with the Telefunken Radio.

Model	Gns.
Philips 3515	32
Sagatone	38
Elizabethan Princess	39
Simon Minstrelle	39
Perth Saja	45
Wyndor Victor	45
Electron	47½
Magnafon	49
Spectone Ex Tape	49
H.M.V.	£50
Telefunken 75 with mic.	56
Perth Saja De Luxe	56
Brenell 3-Star	58
Veritone	58
Mobile	58
Ficora	59
Grundig TK25*	62
Telefunken Deck*	63
Korting Stereo*	68
Telefunken 4-track with mic.	68
Stuzf-Magnetie	69
Brenell MKV with mic.	69
Grundig TK30*	72
Brenell MV with meter, mic.	74
Electron Stereo*	77
Sabafon Automatic*	79
Harting Stereo*	86
Timbra*	89
Simon SP4*	95

Machines marked \* are excluding microphone

## **Dickinsons of Pall Mall Ltd.** 11 Royal Opera Arcade, Pall Mall, S.W.1 TRA 2881

The Royal Opera Arcade lies behind Her Majesty's Theatre in the Haymarket (one minute from Piccadilly Circus or Trafalgar Square).



# Get it **TAPED**—to perfection

— **naturally**



on

MEMBER OF THE B.I.C. GROUP

SIZES	STANDARD			LONG PLAY		
	FEET	TOTAL RUNNING TIME (I.P.S.)	PRICE £ S D	FEET	TOTAL RUNNING TIME (I.P.S.)	PRICE £ S D
3"	150	8mins	5 6	225	12mins	8 6
4"	300	16 "	10 0	450	25 "	14 6
5"	600	32 "	1 0 0	850	45½ "	1 8 0
5½"	850	45½ "	1 7 6	1200	1hr 4mins	1 15 0
7"	1200	1hr 4mins	1 15 0	1800	1..36 "	2 10 0
8½"	1750	1..33 "	2 10 0	2400	2.. 8 "	3 10 0
DOUBLE PLAY			SUPERGRADE			
3"	300	16mins	10 6			
5"	1200	1hr 4 "	2 5 0			
5½"	1800	1..36 "	3 10 0			
7"	2400	2.. 8 "	4 0 0	1200	1hr 4mins	2 18 6

# **mss Mastertape**

MSS RECORDING COMPANY LIMITED, COLNBROOK, BUCKS TEL. COLNBROOK 2431  
MSS SHOWROOM AND STUDIO: 21 BLOOMSBURY STREET, LONDON W1



The phenomenal success  
and amazing popularity  
of the **NEW**  
**SPECTONE 161**  
is due to these facts . . .

1. Latest type recording level indicator which gives the greatest possible accuracy.
2. Three-digit-type place indicator.
3. Three knobs for simple operation of:
  - (1) mains on/off/ tone control;
  - (2) microphone or playback volume;
  - (3) radio-gram volume.
4. Two pairs of recording playback and erase heads for continuous operation.
5. Pause control for momentarily interrupting recording or playback.
6. Compartment for microphone and mains lead.
7. Conforms to C.C.I.R. specifications.
8. Provision for full size 7 in. spools.
9. Built-in facilities for mixing all inputs.
10. Built-in superimposition facilities.
11. Completely self-contained—the lid is fitted with locks and keys and can be removed entirely. It is fitted with hinged flap which contains stowage space for three 7 in. reels of tape. Two reels can also be carried on the deck itself.

**Price 49 gns.**

**Specto**  
LIMITED

**VALE ROAD,  
WINDSOR, BERKS.**



NOW ON SALE

*The fullest, most authoritative and  
most up-to-date survey of stereo*

THE SPRING 1960 ISSUE OF THE  
BIGGER—BRIGHTER—BETTER

**Stereo** Sound and  
music **magazine**

CONTENTS INCLUDE

ADAPTING STUDIO MICROPHONE METHODS TO HOME CONDITIONS  
USING ODD SPEAKERS

FOUR-TRACK RECORDERS — A NEW CONCEPTION OF STEREO  
PROBLEMS OF STEREO BROADCASTING  
STYLI AND STEREO

A DISTINGUISHED CRITIC DISCUSSES THE STEREO ISSUES OF BEETHOVEN  
THE "STAR SEVEN" STEREO DISCS OF 1960  
STEREO AT THE LONDON AUDIO FAIR

GET YOUR COPY NOW—BEFORE IT SELLS OUT

2s. 6d.

*If in any difficulty order direct from the publishers,  
Print and Press Services Ltd., 7 Tudor Street, London, E.C.4*

# TAPE

RECORDING  
AND HI-FI MAGAZINE

Vol. 4      No. 8      20th April, 1960

*Tape Recording and Hi-Fi Magazine is published fortnightly, on alternate Wednesdays, by Print and Press Services Ltd., from 7 Tudor Street, London, E.C.4*

EDITOR: **R. D. BROWN**

TECHNICAL ADVISORY EDITOR: **CHARLES LANGTON**,  
A.M.Brit.I.R.E., A.M.Inst.E.

MUSIC: **EDWARD GREENFIELD**  
*The Guardian recorded music critic*  
**DON WEDGE**  
*News Editor, New Musical Express*

MOVIE-MAKING: **JOHN ALDRED**

NEWS AND CLUB ACTIVITIES: **FRED CHANDLER**

OVERSEAS CORRESPONDENTS:

FRANCE: **GEORGE GINIAUX**  
*Revue du Son, 40, rue de Seine, Paris-6e*

U.S.A.: **PETER M. BARDACH**  
*210-16, Grand Central Parkway, Queens Village 27, New York*

*The Editor is always glad to receive articles, news items, illustrations, etc., intended for publication and payment is made on the first of the month following publication. When not accepted, material will be returned if a stamped, addressed envelope is enclosed, but the Editor cannot accept responsibility for the safety of such material.*

*"Tape Recording and Hi-Fi Magazine" is available by a postal subscription at 45s. per annum, post free, or it can be obtained at newsagents, bookstalls and radio and music dealers. In the event of difficulty, write to the distributors, Rolfs House Publishing Co., Brems Buildings, London, E.C.4.*

*Back numbers, if still in print, are available at 2s. 6d. per copy for issues up to November, 1959, and 2s. per copy for later numbers.*

**EDITORIAL**

Address all communications  
**7 TUDOR STREET, LONDON, E.C.4**  
FLE 1455-6

**ADVERTISING**

All advertising communications to  
**1 CRANE COURT**  
**FLEET STREET LONDON, E.C.4**  
FLE 0197

IN THIS ISSUE

- We take the view . . .** 16
- The World of Tape** 17  
*A news digest*
- New stereo tape cartridges** 18  
Peter M. Bardach
- Stereo Notes** 20  
Douglas Gardner
- Recording in the clouds** 20  
Robert Gunnell

**THE LONDON AUDIO FAIR** 22  
*Special 10-page Supplement*

- Contest Corner** 33  
D. E. Harrison
- B.A.T.R.C. Announcement** 35
- Letters to the Editor** 36
- Transistors** 36  
Charles Langton

- Sound effects** 38  
Alan Edward Beeby

- Electronic Music** 40

- Report from Germany** 41  
*From our Special Correspondent*

- Ideas Pool** 41

- Equipment Tested** 43

- New Products** 45

- News from the clubs** 46

# We take the view . . .

A DIGEST OF NEWS, COMMENT AND EDITORIAL OPINION

**A**NOTHER Budget has come and gone and the iniquitous discrimination against some items of hi-fi equipment and, in particular, against records is perpetuated. There is no logic whatever in a situation in which disc records continue to bear a tax of 50 per cent.

But so it is to be, at least for another year. And this fact, coupled with the news, which we print fully elsewhere in this issue, of significant moves towards stereo tape records may determine long-term future trends in music reproduction.

Manufacturers of tape and tape equipment have a unique opportunity—it might almost be argued that it is an unfair opportunity—to popularise their products during this period when tax anomalies work in their favour. Such opportunity may not be a permanent thing, and therefore a big, bold push at this time seems sensible.

Now is the time when the customer should be made to think tape, to buy tape, and to get used to the idea of using tape. There is already great public goodwill towards the medium—everyone is interested in it. The need is to convince people that the moment has arrived to commit themselves—that the pioneering and experimental period is behind us.

We must combat the outlook wittily described by Paul Jennings in one of his *Observer* pieces recently when, after running through the dazzling attractions of hi-fi, he reached the conclusion:

*“ . . . But still, I think I’ll wait*

*till tape has made these marvels out of date.”*

The public needs to be persuaded that there is no need to wait any longer.

Meanwhile, despite sympathy with the disc firms over their tax handicap, it is good to report that their business prospers. Sales of records in January were valued at £1,372,000—9 per cent up on a year earlier. Sales of stereo records and equipment showed steady expansion. For the first time the demand for stereo discs of some classics was reported to have outstripped that for the monaural versions.

## A question of ethics

**D**OCTORS and church workers are really getting organised on their use of tape. The British Medical Association’s Council recently discussed the “ethical aspects” of using a recorder to take the case histories of

patients. “This is a matter of particular concern in the field of psychiatry,” they explained.

“The Council has expressed the opinion that no objection need be raised, provided that the consent of the patient or guardian is obtained.”

As we have reported in this magazine in the past, many doctors now depend on tape to bring them the latest information about medical techniques. There is already an impressive demand for the tapes circulated by the College of General Practitioners, containing talks and lectures.

These tapes are distributed by rota, each doctor recording his observations before passing them on. After going the rounds, the tape, plus the collected comments, are re-circulated.

I hear from the World Council of Christian Education that their frequent Saturday courses in tape recording are proving most popular. These are open free of charge to anyone connected with Christian activities.

The usual course lasts all day and takes place at the “Churches’ Television Training Centre in London. Under the title “Making the most of your tape recorder,” it covers the place of recorded

sound in Christian education; the choice, operation and maintenance of equipment; recording, mixing and editing technique; and the very latest developments in sound synchronisation and “sound printing.”

Longer courses, and courses outside London, may be arranged, according to demand. Information is available from The Secretary, Churches’ Television Training Centre, Central Hall, Tooting Broadway, London, S.W.17.

## Full coverage

**I**N our recent “readers’ quiz,” you indicated that full and up-to-date information of new products from the manufacturers formed one of the most popular features of this magazine.

That is why we have specially enlarged this issue to include the most detailed and topical review of the Audio Fair that you will find in any publication.

Only in *Tape Recording and Hi-Fi Magazine* are all developments quickly and fully reported.

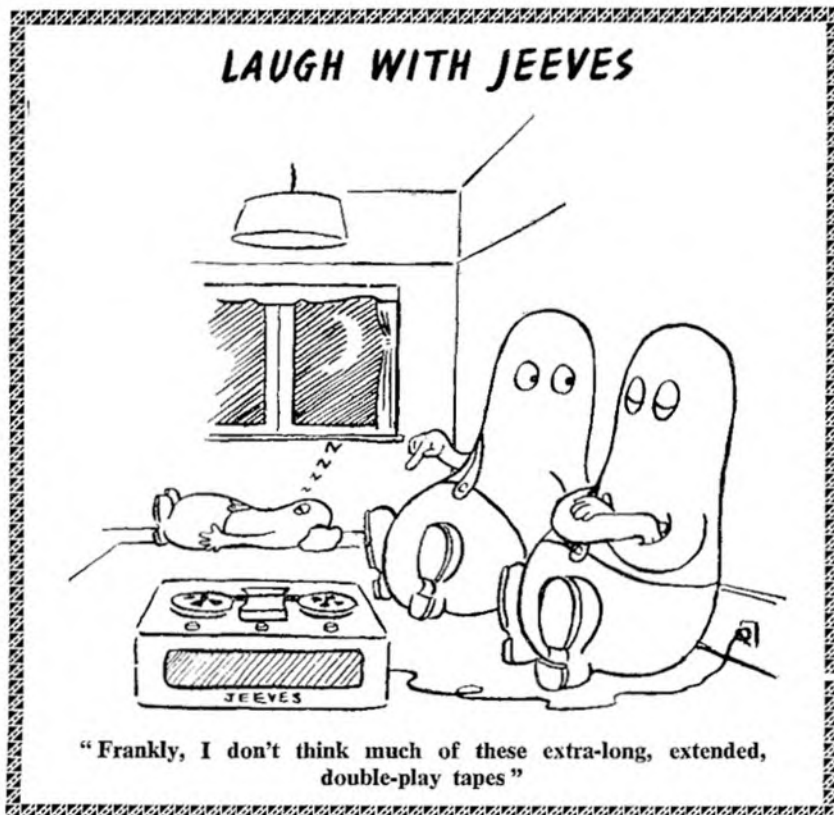

# Dictating machines v. nice legs

E.M.I. CHIEF STRIKES PROVOCATIVE NOTE

**M**R. JOHN E. WALL, a director of E.M.I., told a conference of the London Office Management Association that the productivity of girl typists has risen three to five times as a result of the introduction of dictating machines.

Some girls now type 12,000 words a day, compared with only 1,600 words in some cases previously.

Mr. Gordon King, communications manager of Shell Mex and B.P. Ltd., confirmed these trends. "There is little doubt," said he, "that dictating machines are replacing shorthand writing for routine business correspondence. The main advantage is time-saving."

Mr. Wall was in lively and provocative form when he put his case.

Shorthand is as out-of-date as thick woollen stockings, he quipped.

"It is awfully nice to have a pretty face and nice legs in the office, but is it good for business?" he challenged.

The average shorthand-typist did not spend more than 20 per cent of her time doing shorthand-typing.

"I am not saying these young ladies are idle the rest of the time," he added.

"They are getting theatre tickets and railway tickets and things that are important to business. But they are not shorthand-typists."

## SALESMEN MAKE SECRET RECORD

**S**ALESMEN are reported to be using miniature tape recorders and wrist-watch microphones to make secret recordings of talks with customers. Many have been used by doorstep salesmen. The recorder is kept hidden in an inside pocket.

Every word, even the background household sounds, are recorded. The results are played back at meetings of sales executives.

From them, it is claimed, sales directors can analyse why you did or did not buy.

These recordings can pinpoint the exact moment when the salesman clinched — or lost — an order. Sales techniques are adjusted accordingly.

Firms employing these methods declare that the recordings are kept a strict secret within their organisations.



## NEWS IN BRIEF

**BRITISH RECORDING** enthusiasts who intend to submit tapes for inclusion in the new UNESCO library of recordings should send them to the Federation of British Tape Recording Clubs immediately.

They must be received in Paris, from the Federation, by May 1. A detailed list of all the recordings on tapes submitted should also be sent.

Full information about the scheme was published in *Tape Recording Magazine* on December 30 and February 10.

**COVENTRY'S MODERN** civic theatre, the Belgrade, has been equipped with a full range of G.E.C. sound equipment and stereo reproduction was used to good effect during the first staging of "Never Had It So Good," a play set in Coventry.

Noises-off, which had been specially recorded in the city, included fire-engines, ambulances, church bells and factory production lines.

The Belgrade management has now started a series of free stereophonic lunch-time concerts.

**"BROWNE OFF"** with his wife's marathon chattering on the domestic telephone, a Yorkshire man, aided by his son, cautiously took a tape recording while she was on the phone one evening.

Then they played the recording back at her. It is reported that she was annoyed. But there is no news of the long-term consequences!

*Recording between mouthfuls! Australian TV reporter Panda Lisner caught Hugh O'Brien, star of the Wyatt Earp series, during a break on the Hollywood set, and switched on her Fi-Cord. More than 100 of these battery recorders have been sold in Australia since the firm began exporting there six months ago.*

(Photo by courtesy of GTV Channel 9, Melbourne, and the Australian TV Week)

**THERE ARE MANY** unsuspecting ways (so far as the layman is concerned) in which standard quarter-inch magnetic tape is now being used.

From E.M.I. comes news of an application in a nuclear reactor at the Centro di Studi Nucleari di Ispra in Milan—Italy's "Harwell."

The problem was to find out how the reactor's coolant circuits would behave if the circulating pumps suddenly failed to operate efficiently.

A conventional analogue computer was used as a simulator, but it was then necessary to simulate, electronically, variable transport lags. Now E.M.I. has supplied a Variable Time Delay Unit.

Data going through the computer can now be delayed by a continuously variable amount determined by the voltage applied to a "delay control" input, which accurately controls the speed of a loop of magnetic tape passing pre-set record and replay heads.

The total range of delay is from one-tenth of a second to ten seconds. The superior information-packing density of magnetic tape is fully utilised. A 100-inch loop of tape is used, at speeds ranging from 8 to 40 ips.

# NEW STEREO TAPE CARTRIDGE SYSTEM DEVELOPED BY U.S. FIRMS

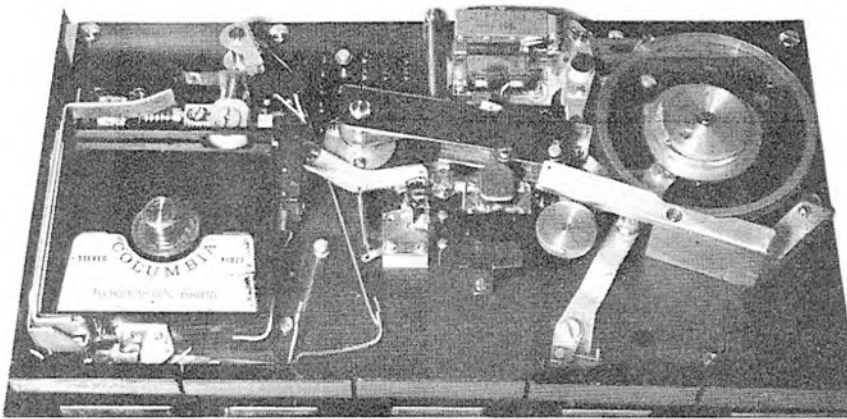

Exposed view of tape deck with cartridge (front, left) in play position

THE perfection of a revolutionary new stereo long-playing tape cartridge was announced here in New York at the annual meeting of the Institute of Radio Engineers. Developed by CBS Laboratories under its president and director of research, Dr. Peter C. Goldmark, the new tape playback system should eventually result in changed standards for both the tape and disc industries throughout the world.

Designed primarily for the playback of pre-recorded tapes (although home recording is also possible) the CBS invention uses a tape moving at the slow speed of  $1\frac{1}{2}$  inches per second past a special stereo record-playback head employing a gap of only one micron.

Sufficient tape is contained within the three-inch wide cartridge to provide 65 minutes' playing time without

## TAPE RECORDING HANDBOOKS

Written by four enthusiasts, experts in their own particular field, these handy-sized guides to four aspects of tape recording should find their way into the pocket of anyone interested in hi-fi and tape recording. A MUST for the newcomer.



### INTRODUCTION TO THE TAPE RECORDER

Charles Langton  
3/6 (4/- inc. postage)

### HI-FI FOR THE MUSIC LOVER

Edward Greenfield  
3/- (3/6 inc. postage)

### TAPE AND CINE

John Aldred  
3/- (3/6 inc. postage)

### HOW TO RECORD WEDDINGS

Paul Addinsell  
3/- (3/6 inc. postage)

Available from:  
Tape Recording and Hi-Fi Magazine  
7, Tudor Street, London, E.C.4

## A special report

from

**Peter M. Burdach**

*Our correspondent in the U.S.A.*

interruption, and without the need for reversing either the cartridge or tape direction. Yet, in spite of this reduced tape speed, a top frequency of 15,000 cycles per second can be reproduced without any noticeable wow or flutter. The much respected music critic of the *New York Times*, Mr. Harold Schonberg, was of the opinion that the new tapes reproduced music with "at least minimum high fidelity." His verdict was shared by other observers, but with even greater enthusiasm.

When production of the new tapes and tape players commences in 1961 here in America, it is anticipated that the cost of the small stereo cartridges will run virtually parallel with that of stereo records. Therefore, the initial cost of purchasing the new deck or complete unit will soon be amortized through substantial savings in tape purchases (contrasted with current prices).

The compactness of the new tape cartridge is attributable to two factors . . . first, the slow tape speed of  $1\frac{1}{2}$  ips, which requires the use of less tape, and secondly, the width of the tape itself. Unlike regular sound recording tapes, the



**Dr. Peter C. Goldmark (left), President and Director of Research at CBS Labs shown with Dr. Carl Barnes, Director of Research at Minnesota Mining and Manufacturing Co. Both men shared in planning the development of new tape machine**

new principle uses a narrow tape that is about one-seventh of an inch in width. The net result is that the three-inch square cartridge unit is only  $\frac{5}{16}$  inch thick.

On automatic models, the change from one cartridge to the next is accomplished much in the manner of the familiar 45 rpm records. The tapes are lowered on a large centre spindle into "play" position.

CBS Laboratories have entered into a licensing agreement in America with the Zenith Radio Corporation, and in Germany with Grundig. However, although early models will go on sale some time in 1961 in America, the European introduction will probably be delayed somewhat.

A subsequent development was the announcement that Minnesota Mining "is nearing completion on construction of a tape duplication centre." This would serve all record interests in the U.S., and would probably function along the lines of United Stereo Tapes, the Ampex sub-

sidary engaged in duplication of four-track  $7\frac{1}{2}$  ips reel-to-reel tapes.

What does all this mean to the current and potential tape recorder user? First, it should be remembered that the new CBS process was designed for PLAY-BACK purposes (although recording can be done at home). The tapes cannot be removed from the cartridges by the hobbyist, and therefore do not provide the flexibility, in many ways, of reel-to-reel tapes for the person interested in HOME RECORDING. Second, and perhaps most important to remember, is the fact that this new invention will not produce "overnight" changes. Current tape recorder models will be on sale for many years to come, and those machines now in use should also prove of genuine value for the future.

Industry observers here recall the introduction in 1948 of the long playing record. It was predicted that within two years all other speeds would be obsolete . . . and yet both 78 and 45 rpm records are still sold in large numbers throughout the world. Speaking of the LP record, it is interesting to note that the same Dr. Peter Goldmark was the developer of this important achievement too. The accomplishments of this relatively young man have never received quite the honour and recognition that is his due. More than any other individual, Dr. Goldmark has probably been responsible for the availability of recorded music at popular prices, and with "high fidelity," to the peoples of the world.

If the new CBS cartridge does produce a market effect on the recorded music industry in years to come, the disc seems likely to feel the impact more than tape. Once the price barrier has been broken, the last hurdle for tape to overcome will have been passed. Meanwhile, therefore, the current and prospective tape recorder owner (particularly the person who uses his recorder for recording) can continue to purchase equipment and accessories now on the market without fear of sudden obsolescence.

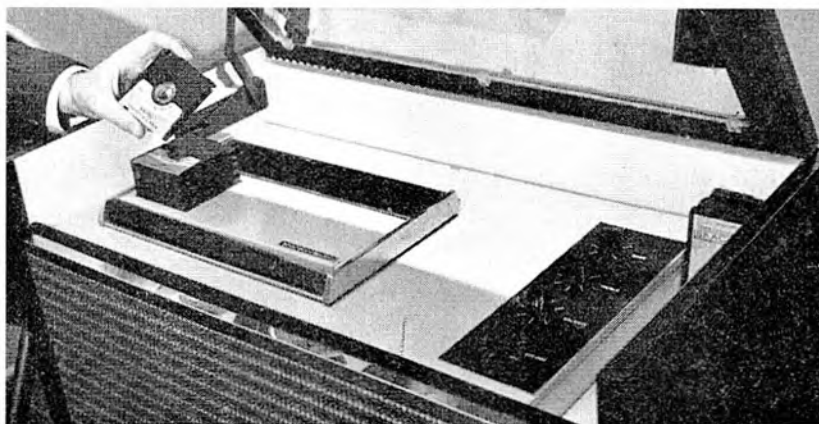

**Close up view of console model with five tape cartridges in playing position**

# Stereo Notes By D. W. GARDNER

## "The ultimate ideal"

WHEN big manufacturing problems are involved even the best ideas can be held up, and possibly killed, simply for want of an agreed standard. Stereo on tape has long been recognised as the ultimate ideal for first-class reproduction, but it has also been bogged down by absence of pronounced enthusiasm for any one of the several ways of achieving the ideal. Beyond a certain point trial and error is economically impossible and we find, too often, that groups of manufacturers (and the public) are just sitting around waiting for somebody to be sufficiently wholehearted about one of the alternatives to enable them to get wholehearted themselves.

It will be a great relief if, as now seems possible, four-track tape at 7½ ips is given a real chance to show what it can do. A steady flow of tapes of this type will encourage people to buy the machines that will play them and permit equipment makers and the recording companies to drive the movement home.

At the Audio Fair we shall be hearing some examples of the four-track 7½ ips tapes offered by United Stereo Tapes, formed recently in America under the auspices of Ampex. They will include some of the finest recordings made by over twenty of the biggest U.S. companies, so that the basic content should be worthy of critical judgment.

What really matters is how well the recorders used can overcome the natural disadvantages of the narrower gap. If you can enjoy the quieter passages, finding them free from background noise and hum, then you will know that an important test has been passed. Remember, as you should always remember in such cases, that the scientific thing to do is to judge by the best examples that you hear. What we want to know is whether extremely high standards can be reached in every respect with the narrow gap and 7½ ips. Once we know that it can be done with equipment that does not cost the earth then it will be merely of academic interest that some machines—or some brands of tape—do not measure up to the required standard.

\* \* \*

NOW on sale at bookstalls (if you are quick), the Spring 1960 issue of *Stereo Sound and Music Magazine*, is extremely good value for money for anyone at all interested in stereo. A glance at the contents will make this clear.

Charles Reid contributes a valuable and fascinating assessment of the available stereo recordings of Beethoven; Edward Greenfield concentrates on recent vocal music, with special praise for Decca's *Peter Grimes*, conducted by Benjamin Britten himself ("... never in

the history of opera has there been a recording of an opera that can so nearly claim to be definitive"); Robert Gower reviews jazz discs issued so far this year; "Stereos" concludes his series on "getting started in stereo" with advice on using odd speakers; H. Burrell Hadden writes on "Adapting studio microphone methods to home conditions"; Charles Langton writes on "Problems of stereo broadcasting"; J. Walton deals with "Styli and stereo"; and Patrick Stevens gives an account of "The versatile bassoon."

The issue also includes an article on four-track recorders, a test report of the Tannoy dual-concentric speaker, and details of the exhibits and trends at the Audio Fair.

You are advised to make sure of your copy before it is too late. There is certain to be a big demand for it.

\* \* \*

BECAUSE I am convinced that stereo stands or falls by its visual acceptability in the home, I take a close interest in the work of people who are concerned first and foremost with cabinets.

Record Housing have got to grips with the problem of stereo by offering three alternative sets of cabinets—obviously backed by a great deal of thought, for they show a proper sensitivity to the conflicting need for compactness when not in use contrasted with correct speaker dispersal when music is being played.

For use with 12-in. speakers, Record Housing recommend two Capriol enclosures with a matching Delius equipment-and-record cabinet. When alongside each other they look as compact as any "radiogram," and as all three units are on castors they can be quickly moved into position for listening. The total cost of the cabinet work is £52.

The second good idea consists of one Nordyk speaker and one Nordyk gram unit standing on a two-unit bench, plus a Nordyk speaker on a one-unit bench. This provides a handsome off-duty row of three units (without a forest of legs), with the opportunity of moving the single speaker to the right relative position for listening. The cabinet work costs £26 13s. 6d.

The third set consists of an equipment cabinet combined with two Viking corner speakers, the latter designed so that they can be hung up to save floor space, the total price in this case being £29 9s. 3d.

I have tried out pairs of Capriol and Nordyk enclosures, with the appropriate Goodmans speakers, in the home and can warmly recommend them as splendid value for money. The Capriols showed up particularly well, and high fidelity enthusiasts might well find that they solve the problem of doing justice to good electronic equipment without incurring an overdraft.

## ADVENTURE WITH A TAPE RECORDER

MOST of our lives we spend with our feet firmly planted on the ground and, so doing manage to provide a wealth of material that can be caught by the intrepid tape recorder. But how much better, when the opportunity arises, to get away from it all and to do our recording in the clouds.

Even in these days, when flying is becoming rather commonplace, there are still very many people who have never felt the thrill of getting completely clear of Mother Earth... and very few indeed who have tasted such "refinements" as returning by parachute. Thanks to the portable tape recorder, we can now all share in their experiences in a very dramatic way, for those experiences can be described and recorded as they are happening!

Theory is one thing, but sometimes ideas don't turn out quite as they are planned.

Some years ago I was looking after a special Scottish edition of one of the B.B.C.'s Younger Generation programmes, which was due to go out very close to Burns' Night, a time revered by all true Scots. One of the items featured the activities of a unit of the Women's Junior Air Corps, based at Prestwick.

The W.J.A.C. possess their own plane and use it to give their cadets their first taste of flying. I planned to send up one of our own young amateur commentators to talk to one of the girls as she took the controls and began to feel the machine respond to her movements. Into the bargain, I hoped for an aerial description of Robert Burns' birthplace, his cottage at nearby Alloway.

Snag No. 1 appeared when we discovered that someone had removed a seat from the plane and it could now only provide proper accommodation for three, instead of four, people. As the pilot, the cadet and the commentator were essential to the venture, I had to stay on the tarmac instead of going along to supervise the recording. I briefed the commentator as best I could—it was his first assignment—and then away they went.



# RECORDINGS IMPOSSIBLE TO ACHIEVE ON EARTH

## *Robert Gunnell writes of planes, gliders and balloons*

About ten minutes later the plane returned and taxied to a halt beside us. Not knowing quite what to expect, I hurriedly rewound the tape, plugged in the earpiece, and listened. There were snippets of description and parts of the interview with the cadet . . . but, snag No. 2, punctuating it all was the vicious sound of machine-gun fire!

They assured me that the flight had been uneventful, so we tested the recorder, but there appeared to be nothing wrong with it. The three took off again, and once more brought back a sound picture of a dogfight. It was curious to say the least.

In desperation, I wedged myself into the space where the fourth seat should have been and prepared to take to the air myself. I knew that recording in a powered aircraft was possible and I was determined to find out for myself what was going wrong. The pilot opened the throttle and we roared off down the runway—only to execute a sharp turn to the right before we were airborne. It seemed that the weight distribution was now wrong, so out I had to get.

It was now almost dark, and the three took off for a last attempt. The phantom machine-gun fire was there again, with a sound so realistic that, played back over a loudspeaker, you almost ducked involuntarily out of range. We never did discover the cause. It was as though the shade of Robert Burns was taking some strange electronic revenge on the Sassenach who dared to commemorate his birth with such modern methods—and on a Sunday, too!

On another Sunday, some years later I found myself at Lasham aerodrome, in Hampshire, making a recording about gliding.

Once you've surmounted the initial feeling of wondering just what is keeping you up there, and "wouldn't it be better if there was an engine—or a parachute—just in case," you realise that gliding is one of the most peaceful, fascinating experiences you can find. After my test trip, I sent

another Younger Generation amateur commentator up aloft. In the recording which he made he caught the tranquility of the scene, the green fields beneath, the distant hills, the strange, uncanny sensation of resting on the air itself.

This time there was no machine-gun fire to break the silence, only the sing of the wind in the struts, which turned into a low roar across the wind-shield of the microphone as the glider banked and began to descend. Here the midget tape recorder had caught more than just words, it had caught an atmosphere, a feeling, something which you could never quite re-create on the ground.

The most unusual recording I have ever made in the air was to get a commentary from a parachutist as he dropped through 800 feet to the ground. This was strictly a job for the expert. No amateur, even if he or she had received proper training, could be relied upon to talk in such a situation.

With parachuting there is no opportunity to turn round and go back. You're on your own, with only one direction in which you can proceed, and that one has a tidy bump at the end of it. So I used an instructor from the R.A.F. station at Abingdon, in Berkshire.

I was told that the most likely time for the attempt would be about sunrise. And so, at a disgustingly early hour, I and the youngster who was to record a "scene set" up top, were shaken from our sleep, fed, and once outside, kitted up with parachutes as a precaution.

The flight sergeant who was to make the drop had had the recorder strapped on to his chest. The small crystal microphone was pinned on to his overalls, in such a position that it would catch his description without hindering his movements. Our small group climbed into the metal cage

which hung beneath a tattered silver balloon. The winch went into action and we began to rise.

On the ground there had been a gentle light breeze, but 800 feet up we found a howling gale which tore at the canvas covering and rocked our precarious perch like a ship in a storm. Such was the background to the "scene set" which my commentator attempted to shout into the microphone.

My parachutist was now ready to go. I doubly checked that his recorder was switched on and working correctly . . . and then checked it again just to make sure! Clipping on the static line which would open his 'chute, he stood poised at the entrance and then, on a word of command, was gone.

Into his microphone went the sound of that vital order, "Green on—Go!" and then, for a second, there was a flurry as he fell forward into space. With a slight crack the parachute opened.

Silence, except for the sound of his voice as he described what lay beneath him; a voice, incidentally, which was completely free of any echo, a situation which it is almost impossible to achieve on earth.

Then there came the struggle as he wriggled out of his seat strap, the ground began to race up, and then, with a thump which shook every valve in the recorder, he was on the ground. His landing was free of mishap, and it is a great tribute to the recorder that it continued to work perfectly in spite of the rough treatment.

The rest of us came down the easy way. The recording exceeded all my expectations and a few days later it became a highlight of a Younger Generation programme. Over a million listeners came to share the experience of that flight sergeant—thanks to the tape recorder.

**THE 1960**

# **LONDON AUDIO FAIR**

**A *Tape Recording Magazine*  
Special Supplement**

The Fifth London Audio Fair will be open to the public from 11 a.m. to 9 p.m. from Friday, April 22, to Sunday, April 24, at the Hotel Russell, Russell Square, London, W.C.1. Admission is free, but only by ticket.

It will be the biggest Fair yet, with a number of overseas firms exhibiting for the first time. An interesting variety of entirely new equipment is to be shown.

*Tape Recording Magazine*, therefore, has prepared this detailed survey for its readers—the fullest coverage of the Fair to be found in any journal.

Those who hope to attend will find it an invaluable guide, if studied carefully beforehand, of what they should look out for, and where it is to be found.

Those who cannot get to the Audio Fair will be fully in touch with all the latest developments if they study the succeeding pages of this issue.

Any last-minute surprises will be covered in our next issue, when we shall publish a special photographic feature on the Fair.

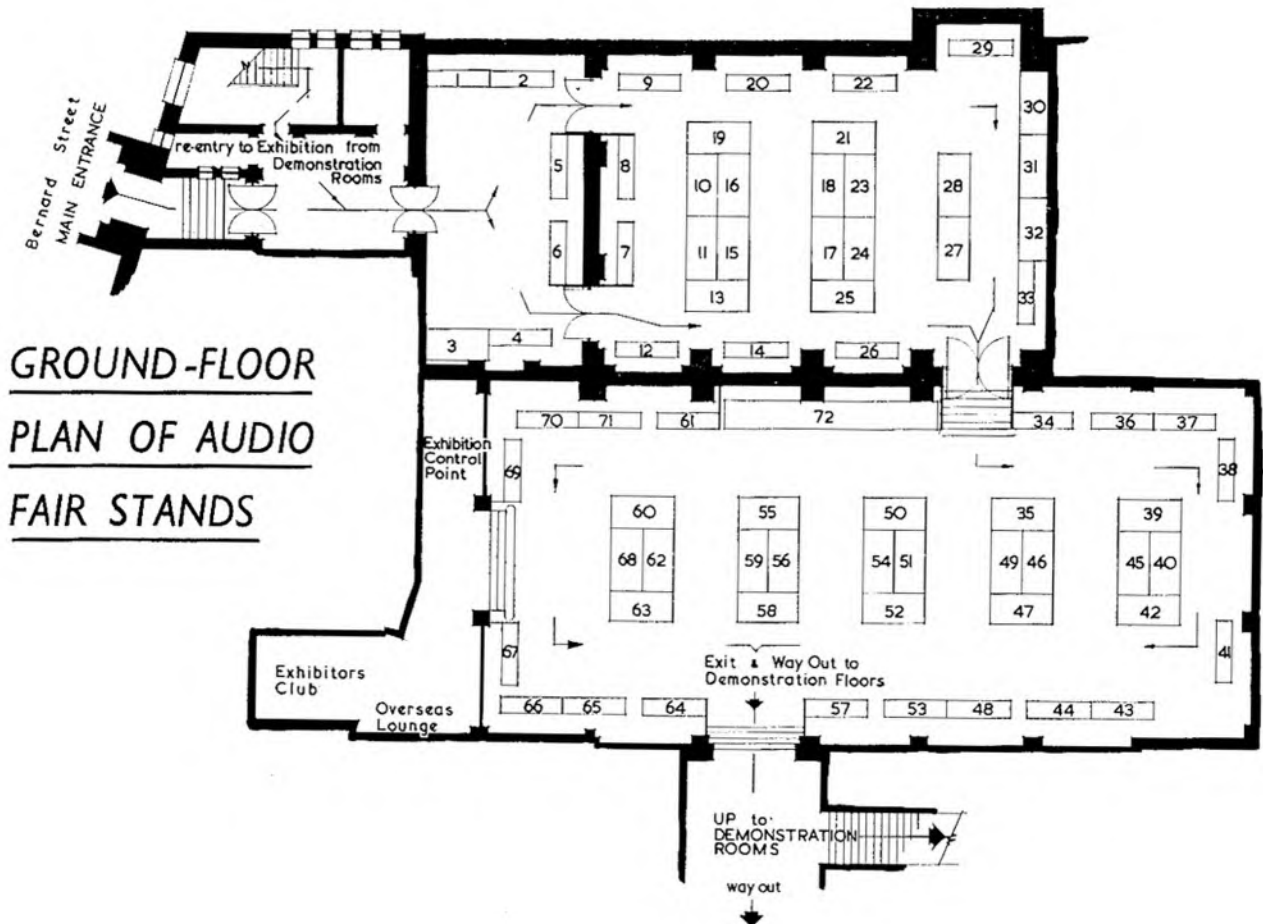

GROUND-FLOOR  
PLAN OF AUDIO  
FAIR STANDS

# STAND-BY-STAND SURVEY *Stands 1 to 7*

## Film about tape - a new splicer - accent on stereo - two new recorders - tape magazine

### AUDIO FIDELITY. (Stand 1, Demonstration Room 112.)

*Audio Fidelity (England) Ltd., London, W.1.*



### BASF. (Stand 2, Demonstration Room 115.)

*F. A. Hughes and Co. Ltd., 4, Stanhope Gate, London, W.1.*

The demonstration room will mainly be used for showing the BASF film, "The Magic Tape." This shows, in thirty minutes of fascinating colour and action, what can be done with magnetic tape. It is an outstandingly good film, as is shown by the awards which it has won in contests for industrial documentary films.

On the stand there will, of course, be the full range of BASF tapes: standard, long-play and double-play in all reel sizes, the special LGS 55 editing sound tape, on the back of which notes can be written, leader tapes, switch foil and splicing tape.

The 1,600 ft. double-play tapes wound on 5½-in. spools have now been superseded by 1,800 ft. tapes, priced at £2 18s. 6d.



### WILMEX LTD. (Stand 3.)

*131, Sloane Street, London, S.W.1.*

This firm will be introducing a tape splicer of a new design, the Irish S.P.3. It will be the only device on the market which embodies twin cutters enabling a professional splice to be made in a few seconds without use of scissors or razor-blade. As little as ¼-in. of tape per splice is used, and the edges are left entirely free of adhesive. There is a

removable base, so that the splicer can be mounted on a recorder.

The full range of Irish tape, an old favourite in America but only recently available here, will also be shown. Wilmex Ltd. anticipate considerable interest in the Irish Sound Plate 220 standard play Mylar tape, a studio grade with optimum fidelity and priced at 54s. per 1,200 feet.



### WHITELEY ELECTRICAL RADIO CO. LTD. (Stand 4, Demonstration Room 304.)

*Radio Works, Victoria Street, Mansfield, Notts.*

Several new items appear in the W.B. Stentorian High Fidelity range, with a particular accent on stereo. This firm, with over 30 years' specialisation, show a keen regard for the latest developments in the hi-fi field.

As a follow-up to the success of the 8-in. and 10-in. units fitted with 16,000 gauss magnets, a complementary 12-in. unit has been designed, fitted with a specially-designed cone and suspension, and with an aluminium voice coil.

This loudspeaker is for use as a full-range reproducer.

To enable users of W.B.12 amplifiers to convert to stereo systems, a stereo control unit has been introduced which can be used with either two W.B.12 main amplifiers or the W.B.8S stereo amplifier.

Exhibited for the first time will be two matching console cabinets to take 8-in. units to be fed from equipment housed in the Prelude Hi Fi cabinets.



### WALTER INSTRUMENTS LTD. (Stand 5, Demonstration Room 122.)

*Garth Road, Morden, Surrey.*

A new recorder in this firm's range, the Walter 404, will make its debut at the Fair. As with all Walter machines, deck, heads and amplifier are all designed and made by the firm, to produce a completely integrated product. The unique Walter "joystick" control is incorporated, with positions for neutral, record, play, fast forward and fast reverse.

The deck accommodates 7-in. reels and there are two operating speeds—7½ and 3¼ ips. Frequency response at the higher speed is quoted at 50 to 12,000 cps.

The machine can be used as a straight-through amplifier, with a quoted frequency response of 40 to 16,000 cps.

Output is rated at three watts, and

signal to noise ratio at better than -35dB.

A 9 x 5-in. speaker is built in, but is muted with an extension speaker is plugged in. A crystal microphone, a 5½-in. spool of tape and a radio/gram record lead and plugs are supplied.

Overall size is 16½ x 12½ x 8½ ins. and weight 24 lbs. The price: 42 guineas.

The 404 can be used with a range of interesting accessories which will also be shown by this firm at the Fair—a Cine Stroboscope which ensures synchronisation of recorder and cine projector (£8 8s.), a telephone attachment for recording both sides of a phone conversation (£3 3s.) and featherweight headphones (£2 12s. 6d.).

Two other Walter recorders—the 505 at 57 guineas and the 101 at 29 guineas will also be shown.



### CHALLENGER INSTRUMENT CO. (Stand 6, Demonstration Room 212.)

*1-2, St. Michaels Road, London, S.W.9.*

This company, which launched the first all-British battery portable recorder, the Minivox, will be introducing a second battery portable at this Fair. Details are not available at the time of going to press. The Minivox model B, which records at 1½ ips, weighs 9 lb, and sells at 37 guineas, continues in production and will be demonstrated beside the new recorder.

Challen will also be showing a portable, battery-operated stereo record-player, fully transistorised, and a portable, battery-operated 15-watt amplifier, fully transistorised, with three-way mixing.



### GARRARD. (Stand 7, Demonstration Room 218.)

*Newcastle Street, Swindon.*

The Garrard magazine tape deck will, of course, be displayed by its makers, but the emphasis on their stand will be on the four-speed record players, transcription motors and pick-ups with which they first established the fame of the firm.

A most interesting new item is the Stylus Pressure Gauge SPG.3, which has a scale of 0 to 12 grammes, with ½-gramme indications, and which is accurate through the entire scale. It measures the exact stylus pressure at the actual stylus and at record level. It is supplied with a 5-gramme checking weight.

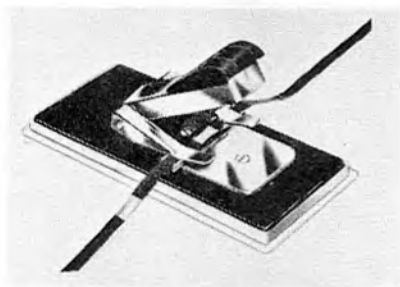

The Irish SP 3 Splicer

## Stands 8 to 15

### BRENELL, (Stand 8, Demonstration Room 117.)

*Brenell Engineering Co. Ltd., 1a, Doughty Street, London, W.C.1.*

The full Brenell range will be displayed and demonstrated again; their reputation is firmly established. Apart from the two recorders—the "Three Star" at 58 guineas with a stereo version at 89 guineas, and the Mark 5 at 64 guineas with a stereo version at £99 12s.—the Mark 5 deck and the Mark 5 amplifier are available as separate units.

As the Mark 5 deck will accommodate up to four heads and 8¼-inch spools and provides four operating speeds, it is one of the most versatile general-purpose decks on the market and very suitable for enthusiasts who wish to build a deck into existing hi-fi equipment.

A standard tape deck with two sound heads fitted is 28 guineas. Extra heads with pressure pads cost £2 4s. each, and a stacked stereo record/playback head is £10.

The "Three-Star" is a handsome machine (recently selected by the Design Centre for display) with three speeds, with frequency correction at each speed. In its stereo version it offers the unique facility of playback on one track while recording on the other—a practice particularly valuable for cine enthusiasts.



### FI-CORD LTD. (Stand 9, Demonstration Room 254.)

*40a, Dover Street, London, W.1.*

The established and popular Fi-Cord 1A will be demonstrated again, with emphasis on the many and varied uses for so portable a light-weight—it weighs only 4½ lbs.

The value of demonstration lies in the quality of recording of which it is capable—Fi-Cord recordings have now become acceptable to the B.B.C. for broadcast. The makers claim a frequency response of 50 to 12,000 cps, plus or minus 3 dB. This, of course, is at 7½ ips, but the Fi-Cord has a second speed of 1½ ips, which makes it suitable for simple dictation.

There is a comparable choice of microphones. With a small dynamic dictation mic fitted with a stop-start switch, the machine costs 59 guineas (including battery re-charger); with a Grampian DP4/M dynamic mic the price is 66 guineas.

There is an interesting range of accessories, which will also be seen at the Fair.



### M.S.S. RECORDING CO. LTD. (Stand 10, Demonstration Room 359.)

*21, Bloomsbury Street, London, W.C.1.*

There will be an impressive display of Mastertape—and an impressive record of achievement for the firm to quote in support of its products. Not only new

## Established favourites—new professional equipment—French arrival—more new recorders

and improved magnetic tape, but videotape and new magnetic heads are now being manufactured.

Behind this activity is more than 25 years experience, since MSS developed the world's first lacquer-coated recording disc. It made the first disc-cutting machines for the B.B.C., and during the last war played a considerable part in many government and military projects.

After the war came Mastertape, now used at modern airports for multi-channel recording, in electronic computers, automation controls, measuring and testing equipment—and for the domestic tape recorder.



### CHITNIS ELECTRONICS LTD. (Stand 11, Demonstration Room 113.)

*1, Long Acre, London, W.C.2.*

This is a new firm since the last Audio Fair, but it will be exhibiting a series of most interesting tape recorders and microphones.

The recorders are all two-speed—3½ and 1½ ips. The KM 22 is two-track monaural, the KM 33 is four-track monaural, the KM 44 is two-track stereo, and the KM 55 is four-track stereo.

All models are supplied complete with microphone and reel of tape.

There are three dynamic microphones—the M50/Tr, the M62/Tr and the Chitnis Stereo.

They will also be introducing the Chitnis-Vollmer studio recorder for professional use, and a stereo playback unit, accommodating 12-inch spools, designed for use by broadcasting concerns.

A professional deck, Type 120, with six heads and a continuously variable speed, adjustable from 0.6 ips to 15 ips will also be on display.

All Chitnis products are of West German manufacture.



### ELECTRONIC REPRODUCERS LTD. (Stand 12, Demonstration Room 347.)

*Camp Bird House, 39, Dover Street, London, W.1.*

Electronic Reproducers are showing and demonstrating the latest models of the "Stereo 60" Ceramic pick-up cartridge, and the "Power point" Ceramic cartridge. In addition to the standard "Power point," a high output version is now available and will be on show, which is claimed to be eminently suitable for use with transistorised amplifiers.

They will be introducing the latest ELAC range of variable reluctance cartridges including the Stereotwin STS 210 and 310.

Also on display will be the "New Windsor" range of replacement diamond and sapphire styli.

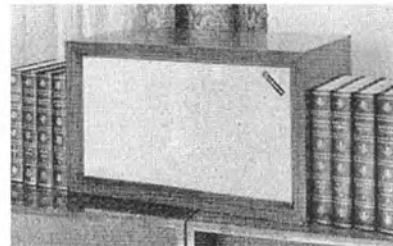

Goodmans AL 100

### GOODMANS INDUSTRIES LTD. (Stand 13, Demonstration Room 242.)

*Axiom Works, Wembley, Mdx.*

Goodmans announce a new AL 100 12-watt, two-way high fidelity loudspeaker system. This measures only 24×11½×14¼ ins., but has a claimed frequency range of 35 to 15,000 cycles. It is similar in appearance to the earlier AL 120 and can be secured in walnut or mahogany finish. The price is £22 10s.

There will be demonstrations of the new and popular 10-in. speakers, Axiom 110 and Axiom 112, which were introduced at last year's Radio Show.

Most of the current range will be available for inspection.



### CONNOISSEUR. (Stand 14, Demonstration Room 318.)

*A. R. Sugden & Co. (Engineers) Ltd., Market Street, Brighouse, Yorkshire.*

Two recently-introduced items will be new to many of the London Audio Fair visitors—the Connoisseur Mark III stereo pickup and the two-speed stereo transcription turntable.

The pickup has a frequency range of 20 to 16,000c/s, ±2dB and downward pressure is 3½ to 4 gms. The diamond stylus is manufactured to .0005/6-in. radius. The price, complete, is £12 19s. 10d.

The new turntable is a 12-in. model, operating at 33½ and 45 rpm. The price is £16 13s. 1d.

Other models of pickup and turntable will also be shown, with the Connoisseur amplifiers and pre-amplifiers, and the Varigr groove recording unit, a disc-cutting equipment priced at £200.



### E.M.I. RECORDS. (Stand 15, Demonstration Room 302.)

*Hayes, Middlesex.*

Complete details of the EMI Records stand are not available, but we understand that HMV sound recording equipment, including the Emisonic and Orthotone units, will be used to demonstrate discs and tapes from their exhaustive catalogues.

## Stands 16 to 22

### GRAMPIAN REPRODUCERS LTD. (Stand 16, Demonstration Room 161.)

*The Hanworth Trading Estate,  
Feltham, Middlesex.*

Among the items being shown for the first time by Gramplan, is the "Vibromajor," an amplifier for the guitar enthusiast, list price £52.

The "Vibromajor" has an output of 25 watts, three separate input jacks, a tremolo device and provision for an extension speaker.

They will also be introducing a new portable record player specially developed for school use with ample output for the assembly hall, and the "Corinthian" stereo outfit, a corner loudspeaker enclosure.

Need we mention that the DP/4 will have pride of place on their stand.



### TEPPAZ. (Stand 17, Demonstration Room 320.)

*170, Boulevard de la Croix-Rousse,  
Lyon, France.*

This well-known French firm should arouse considerable interest with its range of rather gay and remarkable portable record-players. The hi-fi enthusiast will be drawn to the recently-introduced 450 Stereo Amplifier, which offers an output of six watts per channel, and is designed to handle discs and tape.

Among the disc-players, we may select as one example the "Transit," a transistorised model operated by six flash-light batteries, which provide from 150 to 300 hours' playing. It weighs only 7½ lb. and provides four playing-speeds. A choice of attractive finishes—tartan, check, leather or parchment—is offered.

Another product is the 448 stereo portable record-player, which goes neatly into a leather carrying case and weighs only 20 lb. The case divides into three parts—the centre one with the amplifiers, turntable and controls, and the other two to form dual baffles, each with two 7½-in. speakers and a tweeter.

Six watts per channel and a very high quality of performance is claimed.



### ELIZABETHAN. (Stand 18, Demonstration Room 348.)

*E.A.P. (Tape Recorders) Ltd., Bridge Close, Oldchurch Road, Romford, Essex.*

The new Elizabethan Major makes its bow at the Audio Fair and will be available at 65 guineas. It was illustrated in our last issue. The Major is a three-speed machine—7½, 3½ and 1½ ips. Three-micron gap recording heads are claimed to give it outstandingly good recording quality.

Frequency response is quoted at 50 to 20,000 cps at the top speed, wow and flutter at not more than 0.15 per cent at 3½ ips, signal to noise ratio at better than 43dB unweighted.

A meter is used for recording level indication. A push-pull output stage feeds six watts into a matched twin-speaker system—a 10 x 6-in. and a moving-coil tweeter.

Seven-inch reels can be accommodated. There is a precision place-location indicator. Two-channel mixing is provided for, with independent control of each input, and there are separate bass and treble controls.

Two favourites in the Elizabethan range, the "Princess" at 39 guineas, and the "Avon" at 27 guineas, will also be shown.



### AUDIOMASTER. (Stand 19, Demonstration Room 317.)

*W. & N. Electronics, 80/2, Uxbridge Road, London, W.5.*

Another firm with the accent heavily on stereo is Audiomaster. Latest units in their range are the Colwyn Stereo Amplifier and Pre-amplifier. The first costs 24 guineas, the second 21 guineas.



The power amplifier is designed to give 15 watts output per channel at frequencies between 40 and 20,000 c/s. The pre-amp has input sensitivity high enough for any magnetic pick-up and a switch enables crystal pick-ups to be used without further adjustment. Full equalising for signal direct from tape head is provided at 7½ and 3½ ips.

Another interesting item in this firm's range is the Audiomaster Tape Adaptor, a self-powered tape amplifier, with separate playback section, which enables full advantage to be taken of decks with a monitoring head. Equalisation is provided at the turn of a switch for 3½, 7½ and 15 ips. The price is £26 14s.



### ROGERS. Stand 20, (Demonstration Room 213.)

*Rogers Developments (Electronics) Ltd., London, S.E.6.*



### SPECTONE. (Stand 21, Demonstration Room 114.)

*Specto Ltd., Vale Road, Windsor, Berks.*

An entirely new recorder, using the Garrard magazine deck, will be introduced at the Fair by Specto, to be known

as the Spectone 171. A photograph appeared in our last issue. The price is expected to be 39 guineas.

The 171 offers a playing speed of 3½ ips. Frequency response is quoted at 50 to 10,000 cps ±3dB, hum and noise at better than 40dB below peak output, and wow and flutter at better than 0.2 and 0.1 per cent respectively.

There is an erase socket which is used when superimposing one recording on top of another. Inputs are provided for microphone and radio, and outputs for extension amplifier and extension speaker.

A 7×3-in. speaker is provided, and a hand crystal microphone is supplied with the machine. There are mixing facilities on record.

Size is 14 × 12½ × 6½-in., with the lid closed, and the weight is approximately 21 lb.

The Spectone 161, which uses the Collaro mark IV deck and so provides three playing speeds, will also be featured. This costs 49 guineas.



### WHARFEDALE WIRELESS WORKS LTD. (Stand 22, Demonstration Room 337.)

*Idle, Bradford, Yorks.*

Wharfedale are going to demonstrate what an amazing improvement can be secured by using a tape recorder with a full-range cabinet speaker of moderate size and price.

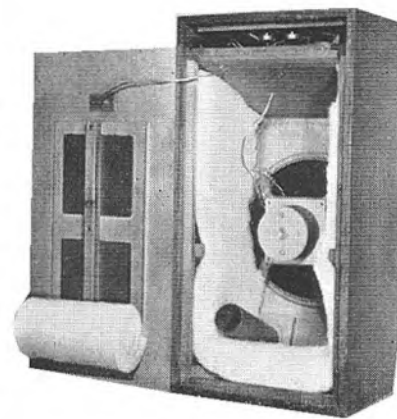

**Wharfedale W. 3**  
(exploded view)

Their PST/8 cabinet, which measures only 24 × 12 × 12 inches and costs £10 10s. veneered and polished, will be fitted with a super 8/FS/AL unit costing £6 19s. 11d. This can be supplied in three to six ohms or 10 to 15 ohms to match the output of normal recorders.

Apart from the demonstrations, Wharfedale will be showing a representative range of their speaker units, from 3-in. to 15-in. diameter.

## Stands 23 to 30

### SCOTCH BRAND. (Stand 23, Demonstration Room 259.)

Minnesota Mining and Manufacturing Co., 3M House, Wigmore Street, London, W.1.

Scotch Brand will be showing two new lines—a new 5½-in. reel with 1,700 feet of double-play tape, and a completely new 3-in. reel which has been named the "One-Five Special." This latter comes in an attractive red and green pack designed for easy mailing. Its 150 feet of tape provide 15 minutes twin-track recording, at 3½ ips, for 5s. 3d.

The firm reports great popularity for the No. 200 double-play, tensilised polyester tape, which was first marketed last year. Also in the range are the No. 111 and 311 all-purpose tapes and the No. 150 extra-play.



### LUSTRAPHONE LTD. (Stand 24.)

St. George's Works, Regent's Park Road, London, N.W.1.

Lustraphone have produced a new catalogue in time for the Audio Fair and the range of microphones and associated equipment shown, and which will be available for inspection at the Audio Fair, is very impressive.

Nearly three dozen microphones, of every type, are included, a range of microphone inserts, a transistorised four-channel mixer, an automatic gain control unit, four transistor amplifiers, a range of transformers, public address systems, a wide selection of stands and bases, and a number of interesting accessories.

Tape enthusiasts are now beginning to realise that no one microphone can do everything equally well, that different applications require different types. Microphone selection is an art and a great deal about it can be learnt by study of a comprehensive range.

The Lustraphone stand, therefore, will be an education to the intelligent recording man or woman. Apart from the orthodox types of mic for general-purpose work, there is a new miniature noise-cancelling model and the Dualhead ribbon-velocity stereo mic.



### G.E.C. (Stand 25, Demonstration Room 355.)

Magnet House, Kingsway, London, W.C.2.

Stereo tapes and discs will be demonstrated by this firm, using three of its latest loudspeaker cabinets in turn. The demonstrations will last about ten minutes at rush periods, and will be on request at other times.

The cabinets to be used will be the Slender and Octagonal Periphonics and the single-speaker Bookcase model, which is only 10 ins. deep. All will be used with the BCS 1416 stereo console.

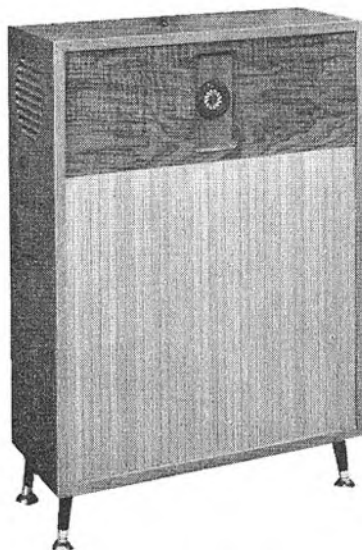

G.E.C. Slender Periphonic

On the stand a new version of the VHF/FM tuner will be shown, known as the BCS 1352A. This has a much-increased performance.

Other items to be shown are the metal cone speaker with power bracket, the BCS 2495 stereo combiner, presence units, bass and filter chokes and the BCS 2417A/18A amplifier.



### ARMSTRONG. (Stand 26, Demonstration Room 120.)

Armstrong Wireless and Television Co. Ltd., Warlters Road, London, N.7.

A new Armstrong VHF tuner, known as model T4, is being introduced at the Fair by this well-known firm. It is self-powered and designed for operation with any high quality amplifier. A pre-set output control, together with the cathode follower output stage, means that it will match virtually any amplifier input without adjustment.

The manufacturers add this interesting statement: "Although it is not yet certain which method the B.B.C. will use when regular stereophonic transmissions commence, we confidently assume that it will be a multiplex system. To anticipate this, an output for a multiplex unit is provided so that this can merely be connected when the time comes. We shall be able to supply such a unit if and when these types of broadcasts materialise."

The tuner gives full Band II coverage, from 87 to 108 M/cs.

Armstrongs will also show their very full range of amplifiers, control units, and radiogram chassis.



### AMPEX. (Stand 27 and 28, Demonstration Room 252.)

Rank Cintel Ltd., Worsley Bridge Road, London, S.E.26.

This will be the first complete showing in this country of Ampex domestic

recorders. Virtually the complete range will be included.

The demonstrations are intended to show the capabilities of a variety of professional equipments. There will be single-channel reproduction at 7½ ips on a 601 portable recorder, two-channel at 7½ ips on a 601-2 portable with two matching speaker-amplifiers, then two-channel at 15 ips on 351-2 equipment and, finally, three-channel on a 300-3 equipment.

Also to be demonstrated are the 970 stereo monitor recorder which has been introduced this year, the 960 portable recorder/reproducer, a new range of Cintel transistor power amplifiers, audio control centres, stereo tuners, a stereo head set, and four-track tape records from the U.S.T. catalogue which, as exclusively announced in *Tape Recording Magazine* recently, are now to be vigorously marketed in this country.



### FERROGRAPH. (Stand 29, Demonstration Room 234.)

British Ferrograph Recorder Co. Ltd., 131, Sloane Street, London, S.W.1.

Ferrograph will be demonstrating stereophonic sound continuously throughout the Fair and arrangements have also been made to provide a question-and-answer service in an adjoining room.

On the stand the series of four Ferrograph mono recorders, plus the model 808 stereo/mono model, will be shown.

In addition, a full complement of accessories—Hublock reels, screened and unscreened jack plugs, screened cable connectors, the De-Fluxer—will be on view.



### RECORD HOUSING. (Stand 30, Demonstration Room 237.)

N. & S. B. Field and Co. Ltd., Brook Road, London, N.22.

This firm, which already has many handsome products at sensible prices to its credit, now introduces a new Viking reflex corner enclosure, designed either to stand on legs or—if you want to save floor space—to be suspended in the corner of the room. It should have a special appeal to stereo enthusiasts.

The Viking is designed for the Goodman's 8-in. Axiette or Triaxiette speakers and is constructed entirely of ¾-in. chipboard, lined throughout. The frequency response is stated to be "satisfying flat

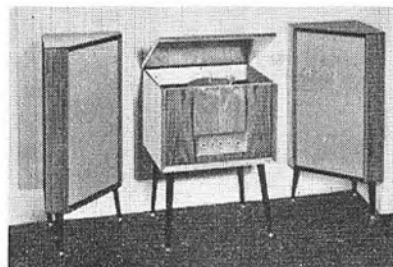

Viking Reflex Corner Enclosures

## Stands 31 to 35

from 40 to 15,000 c/s, due to the inclusion of a tuned port." Additional cut-outs are provided for a 10-in. unit, plus a tweeter, for those who wish to use a multiple system.

There is a choice of three finishes—medium walnut, medium mahogany and light oak—the enclosure stands 32-ins. high (including 6-in. legs), has a maximum width of 19 ins. and a depth of 12 ins. The price is ten guineas.

A new Delius equipment-record cabinet is also being introduced. This is three feet high, 20 ins. wide and 20 ins. deep, and is fitted with castors for easy movement. The motor-board is fixed at auto-change level and is large enough to take any transcription turntable. Radio tuner and pre-amp are mounted on the front panel, while the main amplifier goes below the motor-board. The lower section is divided off to take 150 discs, but can be easily converted for an 8-in. speaker.

This cabinet costs 22 guineas, plus 15s. for the speaker kit, including lining.



### EKCO. (Stand 31, Demonstration Room 256.)

*E. K. Cole Ltd., Ekco Works, South-end-on-Sea.*

Featured in the Ekco display will be the "Nine-Octave" record reproducer model RP341, with its stereo unit, model SU341.

The RP341 is a four-speed player, with auto-change and crystal pick-up with sapphire styli. A 10-inch speaker and a matched pair of 4-inch high-frequency units handle 8 watts per channel. The model gets its name from its claim to handle 30 to 16,000 cps with remarkable freedom from distortion.

The RP341 costs 50 guineas, and the stereo unit, which incorporates a matched amplifier and triple speaker system, is priced at 28 guineas.

Both units are housed in walnut-veneered cabinets and stand on elegant, slim legs.



### DESIGN FURNITURE LTD. (Stand 32, Demonstration Room 211.)

*Carnwath Road, London, S.W.6.*

Some very handsome furniture will be shown by this firm, including an outstanding new amplifier cabinet known as the EQC2. This is made to house amplifier, transcription motor and tape-deck, and to provide storage for up to 140 records. It is veneered in walnut, with a rosewood front panel.

The control and motor board are removable, the latter being adjustable, from 2½ and 5½ inches deep. The overall dimensions are 28½ inches high (with 6-in. legs), 36 inches long and 18½ inches deep. The price is £28.

There are a number of other beautiful cabinets in the range, including a cheaper

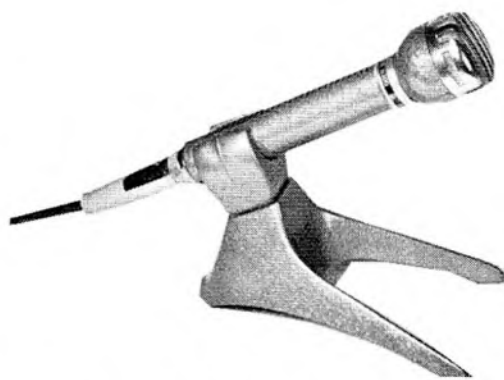

A.K.G. Microphones D 12 (left) and D 19 B with ST 19 stand

and smaller equipment cabinet at £14, and two speaker cabinets, at £7 12s. 3d. and 13 guineas.



### RESLOSOUND LTD. (Stand 33, Demonstration Room 22.)

*Spring Gardens, London Road, Romford, Essex.*

Reslosound will be showing their range of ribbon velocity and cardioid microphones, coil dynamic microphones, including type DP for general purposes, and a new type CD with cardioid response pattern.

As an entirely new feature, these microphones will be demonstrated with transistor couplers in alternate with the usual transformers. These couplers employ grounded base circuitry, have a wide input range, and a normal life of about two years without battery service.



### POLITECHA (LONDON) LTD. (Stand 34, Demonstration Room 312.)

*357, Euston Road, London, N.W.1.*

The very wide range of A.K.G. microphones from Vienna marketed in this country since 1958 by Politechna, will be well represented at the show. A large number of them are of professional standard, but there are a number of mics which should have a wide appeal to amateur recording enthusiasts.

Two of these—the D.88 stereo and the D.11N—have been described and illustrated in recent issues of *Tape Recording*.

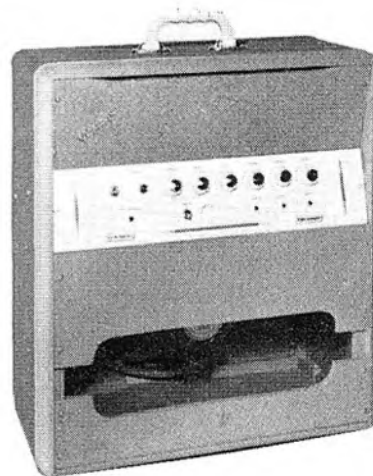

Grampian's "Vibromajor"  
(See page 25)



### STANDARD TELEPHONES & CABLES LTD. (Stand 35.)

*Connaught House, Aldwych, London, W.C.2.*

Of particular interest to hi-fi enthusiasts will be the 4038-A ribbon microphone displayed on this stand. This has an accurate "figure-of-eight" polar characteristic in both planes, a smooth



Design Furniture EQC 2 Cabinet

## Stands 36 to 39

response extending to 15,000 c/s, and an excellent transient response.

Much of the space on the stand will be devoted to "microphones you see on TV" — the broadcast-quality range, which includes types for general purpose, studio, interviewing and outside broadcast work.

There will be a Brimar valve exhibit and a new product to be shown is the Triple Crystal Unit for FM band II tuners.

This incorporates a set of three quartz crystals in a single B7G valve envelope for controlling the frequency of the local oscillator stage. A range is available to cover the BBC channels at present in use.



### SIMON EQUIPMENT LTD. (Stand 36, Demonstration Room 255.)

46-50, George Street, Portman Square, London, W.1.

A portable version of the Simon Minstrelle, which has proved an immediate success in its table-top model, is to be introduced at the Fair. Slight changes in design have been made to make it portable, but the facilities provided, the technical specification—and the price of 39 guineas—are identical with the earlier model. This machine incorporates the Garrard magazine deck.

The well-known Simon SP/4—a quality hi-fi recorder—will also be shown, with the stereo adaptor, which houses an identical 10-watt power amplifier, matching speaker and twin-channel pre-amplifier. The adaptor, which clips simply to the side of SP/4, costs 49 guineas.

Simon announce an unusual development in recording—a new and specialised

product which will shortly be available. This is an adaptor which will enable any standard recorder to be used to record ultra-low frequencies, ranging from the (fundamental) zero frequency through the range to 1,000 cycles. This will be useful for medical research in the recording of brain waves, for seismographic and oceanographic survey, for ship and aircraft vibration detection, and for many laboratory applications.



### C. T. CHAPMAN LTD. (Stand 37, Demonstration Room 220.)

Chapel Lane, High Wycombe, Bucks.

This firm will be showing its full range of tuners, amplifiers and control units, both mono and stereo.

Two new units will be seen for the first time—the FM90 switched VHF FM receiver, and the S6BS/FM tuner.

The FM90 is designed to provide a high quality input for modern wide-range amplifiers and recorders. Home, Light or Third programmes are selected by the turn of a switch. Installation is extremely simple.

The price is £19 10s.

The S6BS/FM is a six-stage AM and high-gain FM tuner, described as the finest tuner in the Chapman range, and costing £67 10s. The nine-band AM section consists of six electrical band spread wave bands covering from 11m to 31m, two short wave bands covering 13m to 140m, and normal medium waves 175m to 570m. This ensures reliable worldwide long-distance reception.

The FM section is claimed to provide a quality of input only limited by the transmission.



### WIRELESS WORLD. (Stand 38.)

Hiffe and Sons Ltd., London, S.E.1.



The new Stuzzi "Mannequin"

### STUZZI. (Stand 39, Demonstration Room 361.)

Recording Devices Ltd., 44, Southern Row, Kensington, London, W.11.

The Stuzzi Mannequin, a popular low-priced machine using the BSR deck, appears at the Fair in a dress that will be new to British customers—encased in the smarter, neater cabinet previously used only for export models.

It also incorporates a better speaker now. The remainder of its specification—three hours' playing time, monitor on record, mixing, and so on—are unchanged.

The Stuzzi Magnette, the distinctive battery portable from this firm, will be shown again. One small alteration has been made to it: when earphones are plugged in, the speaker is automatically muted. The price remains at 69 guineas. The Magnette weighs only 8 lb., provides two speeds, and has a very fine performance.

The other machine in the Stuzzi range, the Tricorder, is billed this year as "the smallest and lightest three-speed recorder on the market." It measures 13×10×6 ins. This is the recorder that introduced the 15/16ths of an inch speed to this country. The price is 75 guineas.



Left—

The Simon "Minstrelle" Portable

Right—

The Stuzzi Tricorder





## Stands 40 to 47

**BUTOBA.** (Stand 40, Demonstration Room 356.)

*Denham & Morley Ltd., Denmore House, 173-175, Cleveland Street, London, W.1.*

This company will be exhibiting the German Butoba transistorised recorder. An illustration of the machine can be seen on page 45.



**WIRELESS TRADER.** (Stand 41.)

*Trader Publisher Co. Ltd., Dorset House, Stamford Street, London, S.E.1.*



**Reflectograph Model B**

**MULTIMUSIC LTD.** (Stand 42, Demonstration Room 236.)

*Maylands Avenue, Hemel Hempstead, Herts.*

The new Multimusic deck, already described in this journal, now appears on a second recorder in the new Reflectograph range, which will be shown for the first time at the Fair. This is Model B, a four-track recorder which, by connection to a suitable external amplifier, can be used for either two-track or four-track stereo reproduction.

It offers two speeds—7½ and 3¼ ips. It will not record stereophonically, but the manufacturers announce that conversion facilities will be made available later in order to add this function.

The deck accommodates 8½-in. reels, so that, using double-play tape at 3½ ips, a total recording time of 12 hours 48 minutes is available.

As for inter-changeability with other recorders, tapes recorded on any conventional two-track machine can be played back, and tapes recorded on tracks 1 and 4 only on the Reflectograph can be played back on a two-track machine.

Three heads are fitted and separate record and playback amplifiers and the manufacturers suggest that this is probably the first four-track instrument to provide monitoring of the signal off the tape during recording. Instant comparison of signal and recording is possible.

An exceptionally good frequency response at 3½ ips is claimed. Separation between tracks is given as better than -45dB, and signal to noise ratio at approximately -45dB.

The price is 105 guineas, with a polythene dust-cover, and two types of carrying case are available as optional extras.

## American firms move in—cheapest four-track stereo recorder—new amplifiers—improved disc lines

**SHURE BROTHER INC.** (Stand 43, Demonstration Room 322.)

*95, Hayes Lane, Beckenham, Kent.*

Released for the first time in the United Kingdom, Shure pick-ups, cartridges and microphones are the products of one of America's oldest-established manufacturers of quality audio equipment. Display and demonstrations at the Audio Fair will be centred on Shure moving-magnet pick-ups and cartridges.

The model M212 Studio Stereo Dynetic integrated tone arm and cartridge tracks at 1½ to 2½ gms. and is fitted with a .0007-in. diamond stylus. It is described as "the pick-up for the perfectionist" and sells at £36, plus purchase tax.

A representative range of Shure microphones, including the Unidyne 55S, will be displayed, prior to release here later in the year.



**STEELMAN.** (Stand 44, Demonstration Room 311.)

*Telectronic Ltd., 46-47, Frith Street, London, W.1.*

The Steelman Transitate will be among the battery portables that are likely to attract close attention at this year's event. This is a machine which has already done well in the United States, and it is selling well here now to businessmen who find it convenient to be able to record with the internal dry batteries and then plug into the mains unit when they reach their offices.

One of the features of this recorder's appearance is the handsome leather case, and this is now available in white—as well as black or tan.

This machine weighs under 6½ lbs. without its batteries and, using double-play tape, offers 32 minutes' recording at its lower speed. It has 3½ and 1½ ips speeds available.

The price is £55.

As on previous occasions, a few firms who are not exhibiting in the Audio Fair will be showing products elsewhere during the period of the Fair.

Daystrom Ltd., of Gloucester, will be showing and demonstrating the full range of British Heathkit equipment at the Grand Hotel, Southampton Row, W.C.1. Included will be amplifiers, control units, speaker systems, tuners, oscilloscopes, transmitters, and many other interesting items.

Beulah Electronics will be demonstrating audio test equipment and the "Chelsea" model with which they have just entered the tape recorder market in the first floor lounge of the Cranston's Waverley Hotel, Southampton Row, London, W.C.1.



**Tannoy Dual Concentric Type III 2**

**TANNOY.** (Stand 45, Demonstration Room 336.)

*Tannoy Products Ltd., Dorwood Road, West Norwood, London, S.E.27.*



**GRUNDIG (GREAT BRITAIN) LTD.** (Stand 46, Demonstration Room 202.)

*39/41, New Oxford Street, London, W.C.1.*

The range of Grundig recorders and associated products has been considerably enlarged since the last London Audio Fair, and enthusiasts will be able to see them all. The mains machines range from the TM20 single-speed deck, costing 44 guineas, to the TK60 two-speed mono/stereo recorder/reproducer at 128 guineas.

Between these extremes there are the TK20 recorder at 52 guineas, the TK25 at 62 guineas, the TK30 at 72 guineas, the TK35 at 82 guineas and the TK55 at 92 guineas.

The TK55 is a mono recorder/reproducer and stereo reproducer. The Grundig channel reproducer C.R.1 is a small column speaker enclosure with a built-in amplifier, specially designed for use with the TK55. The C.R.1 reproduces the right-hand channel and the recorder the left-hand channel.

Members of the Grundig staff will be available to answer all queries, of a general or technical nature.



**MULLARD LTD.** (Stand 47, Demonstration Room 233.)

*Mullard House, Torrington Place, London, W.C.1.*

The Mullard stand will feature valves, transistors and components for audio applications. The valve display will comprise the internationally available series of audio valves and the transistor display will include the recently introduced OC26 power transistor, which can be used in matched pairs in class B output stages to give an output of 15 watts.

## Stands 48 to 57

Also to be shown are ferroxcube pot core indicators for use as oscillator coils and treble equalisers in tape recorder circuits and for speaker cross-over networks.

A wide range of technical publications of interest to audio enthusiasts will be available, and Mullard technical representatives will be present to answer inquiries.



### TECHNICAL SUPPLIES LTD. (Stand 48, Demonstration Room 247.)

63, Goldhawk Road, Shepherd's Bush, London, W.12.

The four-track stereo models, Körting, Harting and Elektron will be demonstrated by TSL, together with a new Elektron, the cheapest on show at the Fair. This is the Mk2 version of the earlier 9S/4K model, retailing at 62 guineas.

The remaining well-known range of TSL products will also be exhibited, including the Autophone pick-ups, the TSL-Lorrenz loudspeakers, and the Thorrens turntables. Their Omega and Concertone pre-recorded tapes will be used for demonstrations. Also on view will be the new "Vedette," 29½ guineas. German two-speed recorder mentioned in our March 9 issue.

Three microphones are included in their list of exhibits. A crystal stick mic., model MX3 with stand, retailing at 45s., the TSL dynamic stereo microphone, 19 guineas with transformer (17½ guineas without), and the M1, high and low impedance monoaural microphone—4 guineas.



### TRIX. (Stand 49, Demonstration Room 261.)

Trix Electrical Co. Ltd., 1-5, Maple Place, London, W.1.

Will be showing the Trixette "Comet" Garrard magazine-loading recorder.



### TELEFUNKEN. (Stand 50, Demonstration Room 315.)

Welmecc Corporation Ltd., 147, Strand, London, W.C.2.

Magnetic tape, microphones and recorders.



### CELESTION LTD. (Stand 51, Demonstration Room 352.)

Ferry Works, Thames Ditton, Surrey.

Celestion are showing a most interesting new approach to stereo reproduction—the model G44/1300, which has two 12-in. speakers mounted in a single enclosure, on either side of a dividing partition, and linked with two small high-note pressure type units which are placed near the corners of the listening room.

The complete cost is only £18 10s. It is a very compact system and so suitable for the average home. The single cabinet measures 15 in. high by 42 in. long by 18 in. deep.

The width of sound corresponds nearly to the distance between the smaller speakers. No elaborate cross-over networks are required and the system is completed by a 12 Mfd. capacitor in series with each high note unit.



### PYE RECORDS. (Stand 52, Demonstration Room 152.)

Pye Group Records (Sales) Ltd., 10A, Chandos Street, London, W.1.



### GOLDRING. (Stand 53, Demonstration Room 214.)

486-488, High Road, Leytonstone, London, E.11.

The very wide range of cartridges, styli, transcription units, pick-up arms and accessories will draw disc enthusiasts to this firm's exhibits.

The GL60 and GL58 transcription units are fitted with a new arm which incorporates a slide-in head and a very simple stylus pressure adjustment. This arm, the G60 (also available separately), is wired to accommodate stereo cartridges, moves on newly-designed ball-races and has adjustable height.

The range of Goldring replacement styli has again been increased to include the latest stereo types.



### VORTEXION LTD. (Stand 54, Demonstration Room 147.)

257, The Broadway, Wimbledon, London, S.W.19.

The familiar and justly famous Vortexion tape recorder will be at the heart of the display by this firm. It now has provision for stereo plug-in heads to enable it to provide stereo replay. The price of the basic model is £93 13s.

The Vortexion range includes a number of items of interest to tape recording enthusiasts who aim at the highest standards. There are the four-way mixer and amplifier combined, the four-way electronic mixer, and the three-way mixer and peak programme meter.

Several microphones are also available—a ribbon (type M8) at £8 15s., a dynamic microphone (type VMC) at £7, and a hand-type moving-coil model at £6 10s.

A well-known Vortexion product is the power supply unit to enable mains tape recorders to operate from 12-volt car batteries. This costs £19 16s.

### PAMPHONIC REPRODUCERS LTD. (Stand 55, Demonstration Room 217.)

17, Stratton Street, Mayfair, London, W.1.

Stereo will bulk large on the Pamphonic stand, where the 3001 stereo amplifier (first seen at the Harrogate Audio Fair) will make its London exhibition debut. This is an integrated audio amplifier, with a specially arranged pre-amp section for operation from both crystal and magnetic pick-up cartridges, as well as stereo tape inputs. It has separate bass and treble controls, gives an output of 7½ watts per channel, and costs £35.

The Pamphonic range includes two stereo disc-players, the portable "Sprite" at 35 guineas (the second speaker is in the lid), and the "Otus," a four-speed, automatic-change player at £52 8s. 9d.

Also on show will be the 640 FM tuner.



### H.M.V. (Stand 56, Demonstration Room 342.)

The Gramophone Company, Hayes, Middlesex.



### TRUVOX LTD. (Stand 57, Demonstration Room 334.)

Neusden Lane, London, N.W.10.

An entirely new Truvox recorder is known as the R.6, and is based on the latest Truvox Mark 6 deck, which was fully reviewed and illustrated in our issue of December 16, 1959. The R.6 is a two-speed machine—7½ and 3½ ips—handling 7-in. reels and operating on dual-track standard.

A special feature is the .00025-in. gap of the record/replay head, which has, in the manufacturer's words, "an attainable frequency response of 30 to 15,000 cps at 7½ips, plus or minus 3 dB."

There are push-button deck controls, a pause control, and a speed selection knob which can be operated while the recorder is running. For fast wind the tape is automatically withdrawn from the face of the heads. Output is 4 watts.

The recorder is housed in a contemporary-style cabinet finished in mushroom and beige, with gilt trim.



The Pamphonic 3001 stereo amplifier

## Stands 58 to 69

Truvox will also be showing the Mark 6 deck as a separate item, and the Type M amplifier specially designed to go with it.

The R.7 recorder introduced late last year and already described in these pages will also be shown.



### VERITONE LTD. (Stand 58, Demonstration Room 354.)

16, Station Close, Potters Bar, Middlesex.

A new de-luxe Veritone Venus is announced in time for the Fair. Additional new features on this machine are four speeds—15, 7½, 3½ and 1½ ips, a comparator switch to allow direct comparison between the input signal and the recording on the tape, two independent inputs with separate volume controls to give mixing facilities, and a push-pull ultra-linear output which is claimed to give an undistorted 5½ watts.

The price, with tape, spool and radio lead (but without microphone) is 66 guineas.

The Venus de-luxe is a standard twin-track machine, taking spools up to 7 in., and having three heads—erase, record and playback. There are three motors and the maker's figure for wow and flutter is 0.15 per cent at 3½ ips.

Superimposition facilities, pause control, and digital counter are incorporated. A 10 x 6 in. speaker is built into the cabinet and a sub-baffle, which can be removed and placed in the lid of the cabinet for improved reproduction.

Overall dimensions are 17½ x 15½ x 7½ ins. and the weight is 33 lbs.



### E.M.I. SALES & SERVICE LTD. (Stand 59, Demonstration Room 313.)

Hayes, Middlesex.



### DYNATRON. (Stand 60, Demonstration Room 222.)

St. Peters Road, Furze Platt, Maidenhead, Berks.

Two new models will be featured on the Dynatron stand, following the trend for "packaged" hi-fi. One is a stereo record reproducer with extension speaker, the other an all-in-one stereo radiogram.

The first, known as the "Mazurka," gives six watts per channel output, and has dual ganged tone control with independent bass, treble and volume controls. There is a socket for external radio/tape input, extension speaker switch and socket, and a "left-right" switch, so that the reproducer can be placed to the left or right of the extension speaker. Auto-changer and single-record models are available, both costing 64 guineas.

The all-in-one stereo radiogram is known as model RG17 and is an 8-valve AM/FM model providing 7 watts output per channel and a claimed frequency response of 30 to 15,000 cps. Tape recording output sockets are provided for both channels. A four-speed record changer is provided, and generous disc storage space.



### DECCA. (Stand 61, Demonstration Room 159.)

Decca Radio and Television, Ingate Place, Queenstown Road, London, S.W.8.

In the Decca demonstration room you will be able to see and hear what is claimed to be "the finest record reproducer in the world," the Decca Stereo Decola, which sells at 395 guineas.

This first made its appearance at the 1959 Radio Show. Several modifications have since been made, in accordance with a stated policy of ensuring that this model holds its proud title, and it is now in production.

Decca challenge the arguments of those who say that hi-fi reproduction requires a number of separate cabinets: they do so with a superb Regency-style cabinet which measures 5 feet 6 inches wide, by 35 inches high, by 21 inches deep.

In order to avoid acoustic feedback Decca evolved the floating bass speaker chamber. With two of these, there are a dual array of directional speakers to reproduce the high frequencies, and, of course, a crossover network. Altogether, there are 16 units in this multi-speaker system.

The Decca flss stereo pick-up is, of course, included in this equipment, together with a newly-designed supplementary head for 78's, so that all discs can be played. A micro-lift is fitted as standard.

A four-speed transcription turntable, high quality amplifiers, and VHF/FM radio (with, state the makers, "the fullest provision it is at present possible to make for the reception of stereo sound broadcasts if and when they begin").



### BEAM ECHO LTD. (Stand 62, Demonstration Room 121.)

13, South Molton Street, London, W.1.



### ACOUSTICAL MANUFACTURING CO. LTD. (Stand 63, Demonstration Room 149.)

Huntingdon, Hunts.

So much praise has been lavished on the famous Quad units that there is nothing new to say of them. The full range will be shown at the Fair—the Quad 22 control unit, the Quad II power amplifier, the Acoustical FM tuner, and the Quad electrostatic loudspeaker.

They will not only attract the newcomers who have not yet seen and heard them: old hands make a routine of admiring them again at any opportunity.

### LOWTHER MANUFACTURING CO. LTD. (Stand 64, Demonstration Room 204.)

St. Mark's Road, Bromley, Kent.



### ACOS. (Stand 65, Demonstration Room 111.)

Cosmocord Ltd., Waltham Cross, Herts.



### WAL. (Stand 66.)

Wellington Acoustic Laboratories Ltd., Always, Kings Lane, Wrecclesham, Farnham, Surrey.

The new product on this stand will be the Waltrak pocket audio oscillator, which will sell at £6 10s.

In addition, the firm will be showing its known and established lines—the WAL Tape Eraser and the WAL gain pre-amplifiers.

The Tape Eraser, which costs £7 18s. 6d., cleans both sides of a 7 in. reel in 30 seconds and has a special recess for quick handling of 3 in. message spools.

The Wal Gain is essentially a sensitive pre-amplifier, transistorised and battery-operated, designed to amplify the relatively small output of the modern moving coil or magnetic pick-up or from tape heads sufficiently to load amplifiers which do not in themselves possess sufficient gain to give their full output when directly connected to the pickup.

The mono version costs £5 and the Stereo version £7 10s.



### LANE & POTTON LTD (Stand 67.)

Fleet Street, London, E.C.4.



### PYE LTD. (Stand 68, Demonstration Room 215.)

65, Fairview Road, London, S.W.16.

Pye will be introducing at the Fair two new products in their high fidelity range—the "Mozart" AM/FM tuner unit (model HFT113) and the "Mozart Minor" loudspeaker (model HF8BS).

Chassis and cased models of the tuner, which will be self-powered, will be available.

The speaker is of unusual design and incorporates one 12-in. and one 10 x 6-in. speaker in a relatively small enclosure—the dimensions are 31 x 13 x 9 ins.

Prices and delivery of these new units will be announced at the Fair.

The full "Mozart" range—mono and stereo amplifiers, FM tuner, speakers and cabinets—will be shown. Continuous demonstrations, mono and stereo, will be given, using the full range and so enabling listeners to make careful comparisons.



### CLASSICAL RECORD NEWS. (Stand 69.)

99, Mortimer St., London, W.1.

## Stands 70 to 72

**H. J. LEAK & CO. LTD.** (Stand 70, Demonstration Room 248.)  
Brunel Road, Westway Factory Estate,  
London, W.3.

Among the full range of well-known Leak amplifiers, and pre-amplifiers, there will be a very interesting new product—the "Varislope Stereo" pre-amplifier, on show for the first time. The makers claim it as the most comprehensive pre-amplifier now available.

Handsomely styled, the unit can be used with any suitable Leak power amplifiers to reproduce stereophonically and monaurally from records, tape, radio and microphone, using any pickup, any tape head, any tuner and any microphone available in the world.

The pre-amp automatically draws its heater and anode supplies when plugged into a Leak power amplifier. All controls are of the single-knob, dual-ganged, close-tolerance type.

Four playback characteristics cover all disc records ever made; monaural or stereo radio is provided for; reproduction can be secured direct from a tape head; monaural and stereo microphones can be handled; and there is an extra mono/stereo input.

There are outlets for tape recording from disc, tape, radio or mic.

The price is £25.



**JASON.** (Stand 71, Demonstration Room 221.)

Jason Motor and Electronic Co.,  
London, W.1.



**BBC.** (Stand 72, Demonstration Rooms 144/6.)

Broadcasting House, London, W.1.

The New  
Walter 404  
(See page 23)



**BRITISH SOUND RECORDING ASSOCIATION.**  
(First Floor Gallery.)

Although at the time of going to Press full details of the B.S.R.A. stand were not available, the general lay-out of the stand

will be designed to show how recording and reproduction is used as an aid to industry. An airport recorder, sonic vibrator and similar equipment will be displayed, and the Navy will be represented with exhibits of mine detectors and submarine detection gear.

They will have their usual stand for the sale of publications and the enrolment of members. Technical queries will be attended to on this stand.

## THIS or THIS?



Grundig TK 30

The best way to choose is to have a full demonstration. In other words



Telefunken 75K-15

come to The Recorder Co. and see the whole range of Tape Recorders available, side by side, so that you can

appreciate the merits of one against the other in open competition. The price range of Recorders offered is from £25 to £155. If you live too far to call, our mail-order department is at your service.

★ We are mail-order specialists—free catalogues and full information on request.

★ Free Insurance Policy covering your payments in the event of sickness, accident or unemployment, etc.

★ Open all day Saturday. Fridays until 6-30 p.m.

★ INTEREST FREE H.P. TERMS.

# THE RECORDER CO.

(Dept. T) 188, West End Lane,  
WEST HAMPSTEAD, LONDON, N.W.6

'phone : SW1 4977



## BRITISH-MADE MICROPHONES

consistently specified for  
quality and reliability

MODELS FOR TAPE RECORDERS, STUDIO  
USE AND SPECIALISED APPLICATIONS

See the complete range at the  
AUDIO FAIR, BOOTH 24

or send for literature to

**LUSTRAPHONE LTD.** ST. GEORGE'S WORKS,  
REGENTS PARK ROAD, LONDON, N.W.1  
PR1mrose 8844



D. E.  
HARRISON  
relates—

# HOW I MADE A WINNING CONTEST TAPE

If you are hesitating to enter the British Amateur Tape Recording Contest this year, read this article. It will convince you that everyone has a good chance of success.

PERHAPS you believe, as I did, at this time last year, that to win a prize in the British Amateur Tape Recording Contest you need a couple of Ferrographs, a mixer and half a dozen different types of microphone. No one was more surprised than I was when my entry last year, recorded entirely on an Elizabethan Escort, won first place in the "Compositions" section.

Of course, you need an idea to start with, and mine was fortunately ready to hand. A few months earlier, I had been listening to a broadcast account of a holiday on the Continent, with its full complement of tapes of village vocalists and instrumentalists, and the occasional sound effect recorded in the teleferic or at the docks.

It occurred to me that one need hardly step out of one's home to capture such sounds, and I decided to try it. It took about a couple of hours to knock up a somewhat disjointed and clumsy programme lasting a quarter of an hour.

When the Contest was announced in *Tape Recording and Hi-Fi Magazine* I jumped for joy and set about re-recording and tidying up what had been originally intended purely for private amusement.

"In search of Bunjistan" begins with a commentary. A train is faded up, then down, and the commentary continues with the train in the background. I had no mixer, so the effect had to be produced in some other way.

What I did was to speak the commentary with the tape running (but not recording) and I noted the figures on the digit counter as the introduction ended. Then a pause for the subsequent sound effect, and a note of the figure at the start of the commentary once more. So far, nothing had been recorded.

For various reasons, I then recorded the sound effect first. I ran the tape until the appropriate number showed on the counter; then I began the noise of the train (this was a piece of wood shuffled across a folded newspaper), beginning softly and gradually getting louder, then quietening off again as the number came round for the commentary to begin again. By varying the loudness of the effect itself, I obviated the need to operate the volume control, and I had quite enough to think about as it was.

This done, all that was needed was to superimpose the commentary, again using the counter as a guide. For superimposition, the Escort has an erase cut-out switch, but I found it more convenient to cover the erase head with a

small piece of postcard. The finished product was a faded and mixed tape, using nothing but a single microphone.

Having shown what can be done with the simplest equipment, I must now admit that, had I carried on like that, my tape *might* have been ready in time for the 1960 Contest. But I found that hardly any difference is noticeable if the sound effects are faded up after each part of the commentary instead of in the background of the last few words. So for most of the rest of the tape I recorded the commentary continuously, with pauses to facilitate editing, and the

piano notes and editing out the impact of the hammer on the string, but the impact noise continues far longer than you would suppose. Finally, I recorded the piano backwards (yes, on a single-direction tape recorder).

I removed the head cover and threaded a length of tape inside out on the machine. Then I formed a loop in front of the head assembly and took the tape back so that it made contact with the heads in the reverse direction. The tape then passed round the back of the head assembly and from there on to the tape drive and take-up spool. In studying the

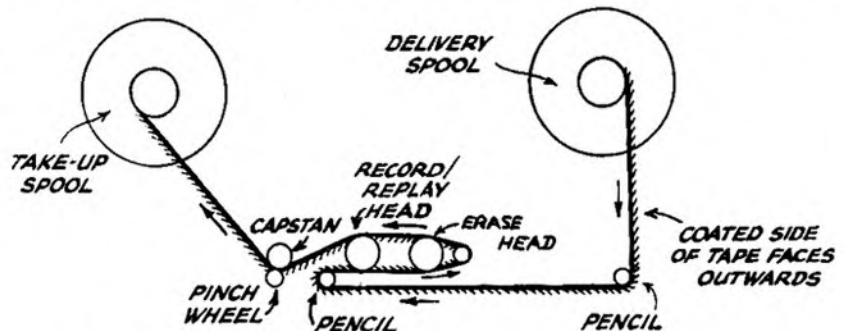

sound effects were recorded separately, and subsequently cut in.

Most of the effects were simple to achieve: a crowd of peasants was four friends recorded six times over on the same tape with the erase head cut out (they were rather hoarse by the end of that!) Rain was made by running the kitchen tap into a washing-up bowl. Plucking the wires of a boiled-egg slicer placed against the microphone (crystal, of course) produced a hideous zither-like instrument.

The most difficult effect to produce was that of a peasant's reed-pipe. I tried whistling, squeaking, and all sorts of vocal contortions—and that is just what they all sounded like. I tried recording

illustration, remember that the Motek deck records the bottom track from right to left.

With that set-up, I recorded a few piano notes, played the tape back in the right direction and the result was—silence! Of course. The tape was passing the erase head *after* recording. When I cut out the erase, the effect was just what I wanted.

The rest of the story is contained in the two words, editing and splicing. Carried out extensively and accurately, they are hard taskmasters, but the pleasure is well worth the trouble.

You may be able to think of more tricks a tape recorder can play. Good luck in this year's Contest!

TURN TO THE NEXT PAGE

FOR DETAILS OF THE 1960

BRITISH AMATEUR TAPE RECORDING CONTEST



IT'S NEW!  
 IT'S ALL BRITISH!  
 IT'S AT THE AUDIO FAIR\*

THE  
**Walter**  
 404

\* Be sure to see the Walter 404 on Stand No. 5—Try it in Demonstration Room No. 122 at the Audio Fair

with new hi-style performance!

This brilliantly designed set is all-British built from components 'made for each other' from the start! In all Walter sets, recording head, tape deck and amplifier are all designed and made by Walter—all perfectly matched. The result is a completely integrated tape recorder—which will vastly extend for you the pleasures of recording and listening. Ask your dealer to tell you about the nation-wide network of Walter service centres!

BRIEF SPECIFICATION: Exclusive Walter 5-position joystick control • 7" reel capacity. Can be played with lid closed. Storage for two 7" reels, microphone and leads • Instant stop/start control • Record safety button • Revolution counter. 3 watts undistorted output • Signal noise ratio better than -35dB • Good dynamic range • Frequency response 40-12,000 cycles • Mixing facilities • 9" x 5" elliptical speaker • Outputs for external speaker and amplifier. Internal speaker MUTED when extension speaker plugged-in • Dimensions 16½" x 12¾" x 8½" deep.

Retail price **42 GNS**  
 Inc. microphone (Terms available)

Also on view at the Fair—Walter 505—the connoisseur's set (illustrated here). At 57 GNS. The set for the younger set—Walter 101. At 29 GNS.



**Walter** INSTRUMENTS LTD.  
 MORDEN • SURREY • PHONE DERwent 4421/5

# 1960 BRITISH AMATEUR TAPE RECORDING CONTEST



*Cups and  
cash prizes*

*Radio Show  
climax*

*International  
link*

*Schools & club  
support*

*Distinguished  
judges*

*Entry forms  
ready*

The 1960 British Amateur Tape Recording Contest is now under way. Applications for entry forms from enthusiastic individuals, from drama groups, from schools and tape recording clubs are now coming in, in record numbers. If you have not written yet for your copy of the conditions and entry form, do so immediately. The address is 7, Tudor Street, London, E.C.4.

The closing date for entries is July 1. Now is the time to begin thinking about your tape—if you are not already busy with it. There are still ten weeks left.

It cannot be too strongly emphasised that this is not a contest suitable only for amateurs with long experience or expensive equipment. The article on page 33 shows what can be done by the newcomer with a popular-price recorder. Many of the prizes in earlier Contests have been won by similar entrants.

There are seven sections to the Contest:

1. *COMPOSITIONS*—Radio plays, dramas, sketches, etc., not exceeding 15 minutes.
2. *DOCUMENTARIES AND "REPORTAGE"*—not exceeding 10 minutes.
3. *MUSIC OR SPEECH*—not exceeding 4 minutes.
4. *ACTUALITY*—unusual voices, historic moments, etc., not exceeding 4 minutes.
5. *TECHNICAL EXPERIMENT*—not exceeding 4 minutes.
6. *CLUB SECTION*—feature tapes of any character on any subject, not exceeding 15 minutes.
7. *SCHOOLS SECTION*—a school "magazine-in-sound," not exceeding 15 minutes.

The three principal awards already lined up are the Emitape Cup for the "Tape of the Year," the Grundig Challenge Cup for the winner of the Schools Section, and the Wyndors Gold Medal for the best technical performance.

"Tape Recording and Hi-Fi Magazine," the sponsors of the Contest, will award ten guineas to the winner of each of the seven sections. Certificates will also be awarded to winners and runners-up.

Other prizes may be announced later.

In addition, the best entries will be automatically forwarded to the International Contest in Holland, where they will compete for other substantial prizes, including substantial sums in cash, in the autumn.

Judging in the British Contest will take place during July—a distinguished panel of judges is now being formed.

The results will be announced, the prizes presented, and extracts from the winning tapes will be heard, at a special ceremony at the Radio Show at Earls Court on Saturday, August 27.

"Tape Recording Magazine" will be hosts at a party for the winners, judges and representatives of the trade and the press. The public will have an opportunity to hear the winning tapes. Further information about this event will be published later.

Arrangements are under way to put tape recording right in the forefront of attention on this day.

Last year, some of the winners appeared on television and had their tapes featured in B.B.C. programmes. We hope that similar arrangements can be made this time. In any case, the winners are assured of an exciting day in London.

**DO NOT MISS YOUR CHANCE OF BEING ONE OF THEM.**

Write now, if you have not already done so, for your entry form. There is no entry fee.

## LETTERS TO THE EDITOR

Have you an idea, a problem, a complaint, or a bouquet to hand out? Write to us about it. Letters not for publication should be clearly marked.

### Is this fair?

MOST teachers would agree with the reference in your recent issue to the tape recorder as "an essential aid in education." However, you may be interested to know what difficulties have to be faced in London County Council schools.

One might imagine that the greatest Education Authority in the country—and one which boasts of its large and wonderfully equipped new schools—would be in the forefront of the tape recording movement. But bureaucracy says "No!"

We are occasionally loaned one (not very suitable) recorder for one school term, in a school of nearly 1,500 pupils.

We are forbidden to buy recorders out of our financial allocation, although we can spend the money on books and other educational requirements. It is rumoured that we might some day be allowed to buy one instrument, provided that it does not cost more than £50—which hardly seems likely to provide a wow-free quality performance, with an output to fill a large school assembly hall.

In any case, we feel that at least two instruments are necessary, both for "dubbing" purposes and for simultaneous use in different classes.

I am a Language teacher; but my English, Music and Drama colleagues feel as frustrated as I do in this matter.

"SCHOOL TEACHER"

London.

### After sales service

THE general public appears to have had some difficulty in getting proper servicing of some makes of tape recorders now on sale in this country, especially some of the imported models.

I would suggest the first rule for the customer is to go to a dealer who specialises in the sale and servicing of recorders. Before purchasing any machine, make sure that it can be serviced promptly and efficiently. One of the important things is that the dealer or agent shall have adequate servicing information from the manufacturers.

I would like to see dealers refuse to sell machines for which such information is not available. Around Christmas, one distributor put a new machine on the market without even a normal instruction book—with only a printed sheet of paper with the various controls marked on it.

The number of machines of British make sent out without servicing instructions, even for dealers, is remarkable, even in the £60-£70 range. A circuit diagram is not sufficient.

Servicing arrangements based upon the employment of an outside national organisation or involving the return of

machines over long distances are not satisfactory in my experience. I believe that the first tape recorder firm to open a factory in the industrial north will be assured of success.

I am ready to share my knowledge of the practice of different firms with anyone who cares to contact me.

There are, of course, firms whose record is good and, in view of what I have said about some imported machines, I should point out that such firms as Telefunken, Grundig, Philips, for example, are excellent examples of Continental firms supplying retailers with all that is needed.

COLIN BRADDOCK

266, Waterloo Road,  
Blackpool.

### What next?

NO doubt we shall be hearing, in the near future, of "recorded instruction" on how to use your new tape recorder—instead of the usual manual in book form.

Excellent, you may say. But what happens when we have arrived home with our new recorder, we plug in the mains connection, place the spool of instruction tape on the deck, and press the starting switch?

We listen carefully. The instructor's voice says: "If, without warning, your tape recorder should cease to function, there are several things that could be wrong, the first being . . ."

The instructor's voice breaks off abruptly. Silence reigns. What next?

Thank goodness that printed instruction manuals continue to be issued with new tape recorders.

JOHN HONE

London, W.12.

### Buy British

YOUR issue of March 9 (page 35) reads that over 60 per cent of 70 members of an ETESSA Club own Continental recorders. I wonder what these people would think if 60 per cent of the buyers of products that are made by the firms they work for, bought these products from Continental suppliers? Would not their jobs disappear?

Maybe the British recorder manufacturers are to blame for not spending as much money as the Germans on advertising, but surely buying British first is essentially a primary consideration for all British people to support their own industries.

PAOLA MEEKINS (MRS.)

Hampstead, N.W.3.

## The first of two articles by our Technical Advisory Editor, CHARLES LANGTON

A.M.Brit.I.R.E., A.M.Inst.E.

TRANSISTORS are small components which are used in tape recorders and other equipment, instead of valves. They are able to amplify a signal, and function in oscillator circuits. Transistors offer many attractive advantages over valves, although at the present time it is not possible for them to completely replace all types of valves.

The small size of a transistor facilitates the construction of small-sized amplifiers. A typical transistor is only a quarter of an inch in diameter, and slightly longer than half an inch, and several can, quite literally, be contained in a thimble. This compares with the size of a miniature valve, which may be two inches high and four-fifths of an inch in diameter.

Miniature construction is further aided by the fact that transistors do not get hot in use. Problems of ventilation are not, therefore, so acute. On the other hand, a valve *does* get hot, first because it has to have a heated cathode, and secondly because the bombardment of electrons heats up the anode. Neither of these effects occur in a transistor, because this component possesses neither heater nor anode. The resistance offered by a transistor to the flow of current through it is very small, and little heat is produced.

A transistor is far more economical to operate from the point of view of batteries. A typical transistor amplifier or radio receiver, using six transistors, may work entirely off two or three torch batteries, and draw less current than a torch bulb. This is in contrast to a valve amplifier which requires an HT supply and LT supply.

The hum level contributed by a transistor is very low, and they are non-microphonic and very robust. They have an unlimited theoretical life, as there is nothing to wear out. This is in contrast to a valve, the emission of which falls off after several thousands of hours use.



# TRANSISTORS

**Tape recorders and many items of associated equipment are now using transistors, instead of valves. One important result is to reduce size and weight. There are other important advantages. This article is a simple introduction to the nature of transistors.**

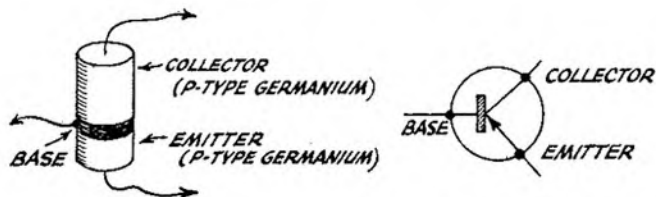

Fig. 1(a)—Construction of junction transistor

Fig. 1(b)—Transistor symbol as shown on circuit diagrams

A study of the construction of a transistor tends to produce a misleading impression of simplicity. Two small pieces of specially treated germanium are separated by a thin slice of germanium which has been treated in a different way. Connecting wires are fastened to each of the three portions, the result (on an enlarged scale) appearing as in fig. 1. As most of the action takes place at the junction surfaces between layers of germanium, this type is known as a *junction transistor*.

The thin slice is known as the *base*, a term which has been handed down from an earlier type of construction known as the *point contact transistor*. The other two pieces of germanium are called the *emitter* and *collector* respectively, the collector being larger than the emitter, but in other respects identical.

To understand the working of a transistor and how it is able to amplify a signal requires a knowledge of how the the germanium is able to conduct electricity.

Germanium is a rare metallic element which in its pure state is an insulator. If a minute amount of impurity is added to the pure germanium, the metal will now conduct electricity, although not as well as the common metals. In this state the germanium is said to be a *semi-conductor*. The impurity may be one of two distinct types. If an exact amount of indium is added, the germanium becomes what is known as a *positive-type* (or P-type) conductor, whereas if the impurity added is arsenic, the germanium acts differently and is known as a *negative-type* (or N-type) conductor.

Referring again to fig. 1, it is seen that a transistor is comprised of two P-type germanium slabs with a thin piece of N-type germanium sandwiched between. This construction is known as the P-N-P transistor. Alternatively, and equally as effective, the construction may be of the reverse order, or N-P-N type. The majority of transistors in present use commercially are, however, P-N-P,

and this article will be confined to this type.

The production of satisfactory transistors depends upon the use of germanium possessing an extremely high degree of purity, and also upon being able to dope this material with the precise amount of impurity. Both processes are difficult to accomplish, and call for air-conditioned workshops to avoid contamination from the atmosphere.

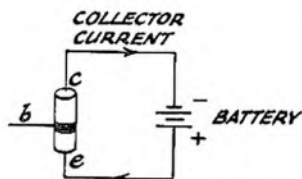

Fig. 2—Showing how collector current flows when the battery is connected

The action of this apparently simple device is very complex and only a practical explanation will be given here. Consider the transistor as being wired into the circuit shown at fig. 2. Here, the base *b* is not connected, and current will now flow from the battery round the circuit and through the transistor from emitter *e* to collector *c*. The battery would have

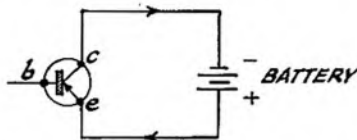

Fig. 3—Theoretical circuit of figure 2

a voltage of between 4.5 volts and 9 volts as a rule, and it replaces the HT supply required by a valve, is sometimes described as the HT voltage.

The current would only be small in practice, but this may be substantially increased by passing a second current into the emitter and out of the *base*. This is called the *base current*. The essential fact is that if the base current is changed by a small amount, the collector current will change by a much greater amount; in fact, collector current may change by almost as much as 50 times the change in base current. This represents a current amplification of about 50. Fig. 4 shows the additional connections for supplying the base current, obtained from the second battery, which should only have a voltage of about 1.5 volts.

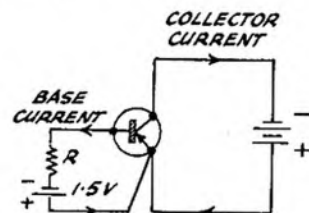

Fig. 4—R is a safety resistor to limit the base current to a safe value, and should be about 4.7K.

As the base current will depend, among other things, on the input voltage, it follows that this current, and hence the collector current, may be controlled by a variation in the input voltage. Therefore, if an AF signal is applied to the input of the amplifier shown in fig. 5, the base current will vary in sympathy with the input voltage, and an amplified variation of collector current will occur. If now a fairly high value of load resistor  $R_2$  is connected in series with the collector and the HT negative, a voltage will be dropped across the resistor. Any variation in collector current will result in a corresponding variation in voltage drop across  $R_2$ . This will be a greater

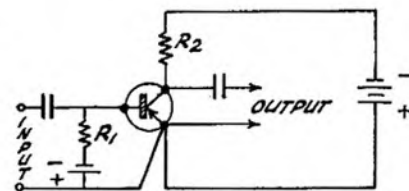
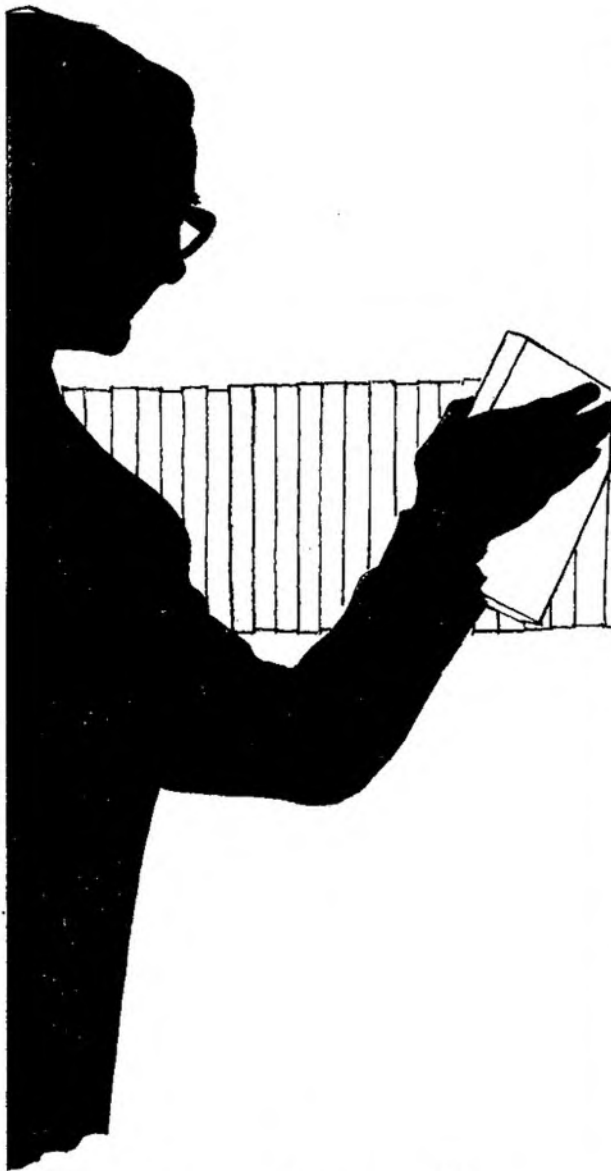

Fig. 5—Complete circuit of a single stage amplifier

voltage than the original input signal, and so *voltage amplification* has been achieved.

This principle is put into practical use when, for example, the tiny output from the replay head of a tape recorder is applied to the input terminals of the amplifier shown in fig. 5. An amplified replica of the signal appears from the collector.



Those who sell  
recommend . . .

TRADE MARK  
**SCOTCH**  
BRAND  
recording tape



WORLD'S LARGEST SALES OF MAGNETIC TAPE

# Sound Effects

**B**ALLOONS find their way into a number of sound effect tricks and one of these is the "creaking door" effect. Blow the balloon up to a reasonable size and hold it in the left hand. The "creak" is obtained by drawing the right hand forefinger over the balloon's surface so as to produce a "stuttering" noise.

There are two ways of doing this, according to whether the door is supposed to be opening or closing. Heavy finger-pressure will give a slow "stutter" and light pressure will give a faster version—more like a squeak.

For the "opening door" effect, the pressure should be heavy and slow-moving to begin with, getting lighter and faster as the door swings open. For a "closing door," this procedure should be reversed.

The sound of THUNDER can be made vocally. Set the machine to record at double-speed and place the microphone close to the mouth. Now, *breathe* the word "POW!" across the face, as quickly and fiercely as possible, ending with a fast, back-and-forth, "rubbing" movement of the lips, at the same time, moving the microphone slowly away from the mouth. Play back at normal speed.

Of course, thunder can be recorded *au natural*, if preferred. The attendant lightning-flash which precedes the sound provides a perfect action-cue for pressing the "record" button. However, there are drawbacks to this practice, especially if, like me, you happen to live in a heavily-populated area.

For instance, some time ago I supplied a thunder effect to a dramatic society for their production of "Mr. Bolfrey." It was during the summer-time and, by a touch of Providence, a thunder-storm presented itself. Thankfully (and rather foolishly) I stuck the microphone out of the window, recorded a few claps and took the tape along to the dress rehearsal.

Talk about a Dawn Chorus! On amplification the tape obliged with a spirited rendering not only of thunder-claps but also of slamming doors, a train whistle, a barking dog (mine), a "pop" record, and a wailing child!

Now to the queries. For those of you who have asked me to devise a fairly simple method of adding echo to speech, I am working on an idea at the moment which seems to be proving successful, using two recorders and a mixer. I'll let you have the working details in the course of an issue or so.

Someone asks for the effect of footsteps on a gravel path. This is easy; I recommend Ovaltine! Put a teaspoonful of Ovaltine in a matchbox, place a thimble on your finger and simply press or grind it into the Ovaltine in time with the footsteps. Don't *tap* the finger or you'll spoil the effect. If you haven't got any Ovaltine, sugar

**ALAN EDWARD BEEBY,**  
who has had long ex-  
perience in devising and  
recording sound effects,  
continues his regular  
column of advice

*If there is an effect you want, and  
which is causing difficulty, write to  
him for guidance.*

will do, although it doesn't give such a good "crunch."

The sound of a voice coming over a telephone or an "inter-com" is usually achieved by having someone talk into an empty cocoa-tin on the "dead" side of the microphone. I suppose it's passable enough if you're not all that fussy about realism, but to me it always sounds extremely amateurish.

Why not invest in one of those little audio-units (sound-powered inter-coms) often advertised in various magazines? They are connected in pairs originally, but it's a simple matter to cut the leads about a yard or so away from the mouthpiece and to connect a plug to fit your recorder.

Audio-units are available from Goodman Fluorescent Ltd., 9, Percy Street, London, W.1.—price per unit (pair) 9s. 6d., plus 1s. 6d. postage.

And now, the RAIN effect. When you've finished rolling dried peas round a tin tray, try the following method. Take a large sheet of rough sandpaper and cut round the shape of a 10 in. gramophone record. Pierce a small hole in the centre and place it on the turntable of a record-player, as you would a normal record.

Thread four sewing-needles with cotton and suspend these from a piece of wood—about one inch below. (Not more than one inch of cotton between needles and wood: this is important.)

Set the turntable in motion, lower the needles just enough to allow them to "dance" on the revolving sand-paper, holding the microphone as close to the needles as possible. In recording this effect you'll find that a fairly high gain level is called for, so be careful not to pick up any motor-hum.

Try one or two variations on the idea, such as running the turntable at different speeds or using a different grade of sand-paper. Drizzle, steady rain, downpour, sleet, etc., can all be obtained by this method.

Finally, to the subject of manufacturing and recording real explosions. I've received one or two letters about this and I do want to emphasise most strongly that *this is not a job for the amateur!*

I've been working with pyrotechnics and explosives for theatrical and out-door demonstration purposes since 1948, having learned the job, initially, under expert guidance and strict supervision, and my advice to any enthusiast considering an experiment of this nature is simply: "Don't!" Unless you have extensive experience in these matters.

If there are any tape and/or cine groups among my readers wishing to employ this type of effect, then please write to me, *c/o Tape Recording Magazine*, and I'll be only too pleased to help in any way I can. But, please . . . **NO EXPERIMENTS!**



*Those who know  
insist on . . .*

**SCOTCH**  
TRADE MARK  
BRAND  
*recording tape*



WORLD'S LARGEST SALES OF MAGNETIC TAPE

# Electronic music at Wigmore Hall

**W**HAT was said to be the first public performance of electronic music in London was given as part of a recent concert in the Wigmore Hall, sponsored by the Institute of Contemporary Arts. Both the electronic works were composed for stereophonic performance, but we heard them in monaural versions.

It may seem at first that stereo is not at all essential for electronic music, since no individual performers or instruments are concerned. Yet it is clear that the use of directional sounds is an important variable at the disposal of the composer, which also helps the listener to identify succeeding sounds, as well as preventing the flatness that marred these performances, contrasted as they were with the live performances of live conventional works that made up the rest of the concert.

The first of the electronic pieces was Bruno Maderna's *Continuo*. This is based on a wide range of electronically-produced tone qualities, from those with definite pitch to those without. These are used as sustained notes and also, to an increasing extent in the later part of the piece, to make short sections of bubbling sound. Out of this material a continuous pattern of overlapping sounds is built.

This grows, from its quiet opening, through a gradual crescendo, to a climax, following which is a final passage in which the dynamics vary more rapidly, and including some very effective sudden entries of the bubbling sounds. Glissando sounds are used occasionally, but they do not altogether avoid the suggestion of something starting up or slowing down, which was unfortunate in a piece of pure music such as this.

Although the crescendo was controlled wonderfully, I found the simple orthodox form inappropriate to music in which most other orthodox features, such as regular intervals of pitch and time, had been dispensed with.

The second electronic work was the Thema "Homage to James Joyce" by Luciano Berio. This is based on syllables and sounds taken from a reading by the composer's wife of extracts from *Ulysses*. The voice is heard in all stages of distortion, from the clearly recognisable to the quite unrecognisable.

It is most clearly heard at the beginning and end of the piece, where much use is made of sibilant sounds. Between these are a number of contrasted sections, each of more limited range, where the voice is hardly heard as such. Although still simple in form, I found this to be a much more original work, that needed to be heard more than once to be fully grasped.

A criticism, almost inevitable in a work based on the human voice, is that most of the high-pitch sounds were made by the babble of speeded-up speech. Is there no way of varying speed and frequency independently?—a problem that has been faced only, so far as I know, in the Goons' *Ying Tong Song*.

## TAPE TITTER

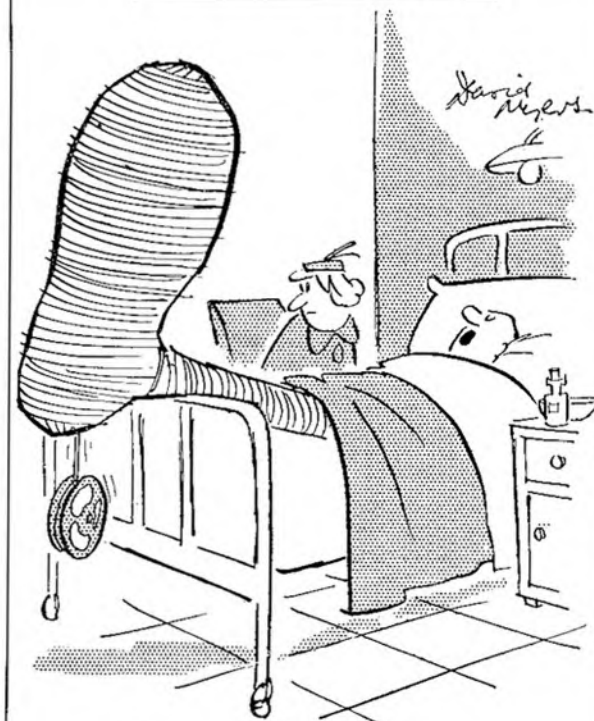

"They ran out of bandage"

Another possible fault arising from the use of a woman's voice was the almost entire lack of bass sounds, except for a note at about 50 cycles that spoils both works. But this was undoubtedly very expressive homage.

It is at the moment a paradox of electronic music that in spite of its much wider range of possible sound than conventional music, it has not yet developed anything like the same range of expression—I am leaving aside the imitative forms of *musique concrète* as having more in common with drama than with music.

This is surely a situation that must change as composers and audiences gain more experience. But it must be admitted that, at present, composers feel the need of a human voice to aid their expression and the music a human reference point, while to most members of an average audience all that electronic music means is a journey into space.

ALAN SUTCLIFFE

# Triumph

## TAPES

BRING A NEW SOUND

TRT. 1000

**I HEAR A NEW WORLD**

**A STEREO OUT OF SPACE FANTASY**

---

**THE BLUE MEN DIRECTED BY**

## ROD FREEMAN

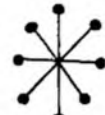
★ TRIUMPH RECORDS, EMPIRE YARD, 538 HOLLOWAY ROAD, LONDON, N.7. ARCHway 6777

WHEN magnetic tape was first invented and developed in the laboratories of I. G. Farben-Werke before the war, it was entirely reserved for the Reichsrundfunk—the state radio system. My own first contact with tape recording was made in the broadcasting studios in Berlin. Private recording was unknown, for there were none of the transportable recorders which are so familiar today.

During the last war, tape was naturally used for propaganda purposes. Important political speeches were recorded and were issued on tape to all German radio stations, for simultaneous transmission.

### Genius

After the war I. G. Farben-Werke was split up into a number of separate concerns. The recording side was developed at Telefunken, but it seems to have

# THE PACE IS HOT IN GERMANY

missed the market in 1948, so that a new competitor, displaying commercial genius, was able to move, not only into the German, but into the export market as well. This was Grundig, which still leads in Germany, though competitors strive hard to produce models with new standards and facilities.

In radio and television studios, however, Telefunken recorders are supreme.

The battle goes on, Philips, Saba, Uher, Saja, Nordmende, Butoba, Körting—all have their own specialities as, for example, the Saba Automatic and the Uher Universal with its additional speed of 15/16ths of an inch per second.

### Dummies

Last year's Hanover Fair set so hot a pace that several of the new stereo recorders on show there were, in fact, dummies. This year's event is likely to be more sedate. The view is growing that, unless the pace in seeking technical improvements is slowed down, the man in the street will decide to hold off buying, waiting to see what is coming next!

But the German market is clearly still capable of absorbing more recorders—the absence of any market in second-hand equipment shows that. The big chance is now there for a model which is easy to handle, light and portable, and capable of being worked from the mains and batteries.

The danger to the industry comes from those recorder owners who stop using their equipment for lack of ideas. Some technical books have been published here to stimulate activity, but none of them has really aroused the imagination.

In neighbouring Austria only one firm is producing tape recorders at present—Stuzzi. Their "Magnette" would undoubtedly enjoy a much wider sale if the price could be reduced.

### Tapes

The market for magnetic tape in Germany is still governed by BASF—formerly I. G. Farben. The several years' lead which they enjoy is difficult to challenge—even by a firm like Agfa—also formerly I. G. Farben—which is now producing tape with some astonishing features.

There are imports of Gevaert tapes from Belgium and of Scotch tape from the United States, and Scotch has some keen champions.

The tape cartridge has not yet aroused much public interest as, so far, there have only been samples from one particular firm.

The lesson of experience in Germany is that the new hobby of tape recording demands from the manufacturer not only good equipment, but close contact with the customer—publicity and public relations work on the scale seen in the photographic industry.



## THE IDEAS POOL

paper, cut to size, on top of a leader tape, using temporary join tape to secure it. In the case of the thicker silver paper I find it quite successful if joined between the magnetic tape and the leader.

DONALD O. COX.

Wanstead, E.11.

### Recording at sea

I AM in the Merchant Navy and am thinking of buying a recorder. My difficulty is in finding a model that will operate on 110 volts D.C. and also on my home voltage. One suggestion I have received is to buy a converter, but the weight of these is considerable and they are not meant for humping around.

Another person suggested "an electronic box of tricks" to take the place of the weighty converter, but I have been unable to check on this. Here in Sheffield nobody seems to stock anything that is liable to be of use at sea.

I wonder if you or your readers could advise me if there are firms which will adapt a particular model or even make a model suitable for both A.C. and D.C. within a price range of £60.

J. M. ASHWORTH.

Nether Edge, Sheffield, 7.

*The only model of which we are aware operating from 110 v. D.C. and 240 v. A.C. is the Marine A227. This machine is manufactured by Amplion Ltd., 175-179, Cricklewood Lane, London, N.W.2. The price is a little over £40. It uses the B.S.R. Monardeck, 3½ ips, accommodates 5-inch spools, and weighs 22½ lbs.—EDITOR.*

WITH reference to M.F.B.'s (Rugby) letter in the *Tape Recording and Hi-Fi Magazine* (27 January), owners of Ferrograph tape recorders may be interested to know that the screw of the pause control on that machine will accept the Leica cable release (of Leica models IIIf, at least).

There is also available from Messrs. Wallace Heaton the Kagra cable release, which can be operated at a distance of over thirty feet. It is possible to obtain a Leica bush to fit on this cable release, and this will, of course, enable the cable release to be used with the Ferrograph pause control.

JOHN C. S. BEARNE.

London, N.W.6.

### Silver paper as brake foil

I HAVE recently discovered a tip which may interest some other readers, regarding automatic brakes operated by the tin-foil method. I find that ordinary silver paper, such as provided with tobacco, operates the brakes quite well. If the silver paper from cigarettes is used—this is normally quite thin and liable to break—I mount the silver

# BOGEN TAPE HEADS

## 2 AND 4 TRACK FOR STEREO & MONO

Bogen Tape Heads are found in fine recording equipment all over the world. They are made by Bogen of West Germany who specialise exclusively in the manufacture of magnetic heads to extraordinarily high standards of design and performance. Many new and original techniques are used in their production, the results of which are instantly apparent when using Bogen heads. Particular attention is drawn to Bogen 4-track heads for stereo and other multi-channel requirements. These are supplied in sets for record/replay and erase. Two-track stereo and mono heads are also available.

- **FREQUENCY RESPONSE:** 30-16,000 c/s at 3½ ips; 30-10,000 c/s at 1½ ips. using high quality tapes and amplifiers.
- **MAGNETS:** Finished to micro-precision standards of accuracy.
- **GAP:** 3.5 microns (0.0001375") ground and lapped (twice as good as normally accepted standards).
- **SCREENING:** All heads mu-metal shielded.
- **CONSTRUCTION:** To very small size, with screened leads. Mono heads faced with special plastic surround to ensure perfect contact.

Set of 4-Track Heads for Record/Replay and Erase **15 gns** retail

**TRADE ENQUIRIES INVITED**

- **SPECIAL TERMS TO MANUFACTURERS**

*Details on request from the sole distributors for U.K. and the Commonwealth*

**GOPALCO, LTD.,** 1, LONG ACRE, LONDON, W.C.2

Phone: COV 2052

# DIXONS

OF MANCHESTER

offer you

## TAPE RECORDERS ONLY

In addition to supplying all good makes and stocking almost every accessory, we are the main service and sales agents for the famous Telefunken.

Our service department cannot be equalled in the

North and is up to Telefunken and Grundig standard so that we are able to implement maker's guarantee on most makes without returning to manufacturers.

Tapes, microphones and all spares by return of post and reasonable H.P. terms available.



## DIXON'S TAPE RECORDERS

227, Oxford Road, Manchester

ARDwick 4269

# MOTEK

*Patents Pending.*

## 3 SPEED TAPE-DECK

The Motek tape deck is both the heart and backbone of a multitude of recording machines.

Confidence in Motek, felt by manufacturers and enthusiasts alike, grows with the technical excellence of Motek equipment.

Three speeds, pause control, push-button operation, accidental erasure prevention, positioning counter . . . these are a few of the outward signs of internal quality.

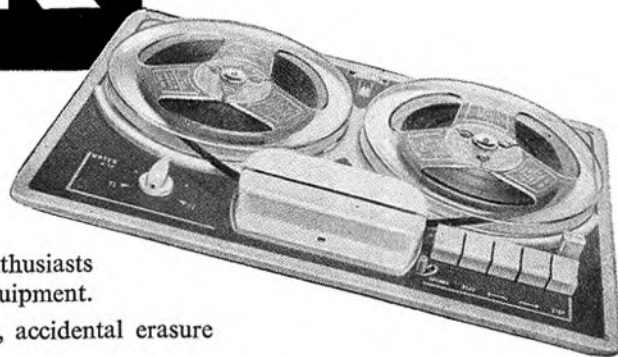

**List 21 gns.**

*Details of K10 (as illustrated) on Request.*

## MODERN TECHNIQUES

Wedmore Street, London, N.19 Tel.: Archway 3114



# Equipment Under Test

---

## THE SYMPHONY MK. 3

By  
William  
Dobbs

**T**HE Symphony Mk. 3 Tape Recorder costs 52 guineas and the comparatively low price for this well-constructed domestic class instrument is simply because the distributors, Northern Radio Services, supply direct to customers.

No microphone is supplied, for the makers believe that many users of a tape recorder prefer to choose their own. This is a good point; there is no sense in paying for a microphone with which one cannot enjoy the full advantages of a good machine. Northern Radio Services can, however, supply various types of microphone and recommend their "Coronation" sound cell hand instrument at £3 (12s. 6d. extra with a table stand).

The Symphony recorder utilises the Truvox Mk. 6 deck, which I reviewed in these pages recently. My only criticism of it is the unusual braking and stop system, which is a little tricky at first, but providing one acquires the habit of pres-

sing the braking button first, operation is at least positive.

The deck employs three, shaded pole motors, so that very fast forward and reverse winding is available. A comprehensive instruction booklet and a 7-in. spool of BASF tape are supplied with the machine. It is worth noting that there is space for a Truvox stereo/record playback head, which may be mounted in place of the original recording head.

The Symphony also uses a Truvox record/playback amplifier Type K, which in itself is an excellent amplifier and is provided with two recording inputs, one for microphone and one for pick-up or radio. An additional socket provides a monitoring while recording facility which may alternatively be used for connection to an external amplifier. A socket is also fitted at the back of the recorder to make provision for an external loudspeaker, and it automatically cuts out the internal speaker when in use.

Deck facilities include a magic eye recording level indicator and a dual operation control which takes care of

both volume level and treble lift. As a reminder that recording is to be carried out, an interlock button is situated on the amplifier front panel. The deck is push button controlled and, for the benefit of those who have not seen the review on this deck, the remaining facilities include a pause control, tape position indicator and, of course, a changeover switch to select either of the two speeds,  $7\frac{1}{2}$  and  $3\frac{1}{2}$  ips.

The recorder is fitted with a 7-in. elliptical speaker from which reproduction at the lower frequencies is considerably improved by the large baffle area of the cabinet.

The instrument is attractively finished in brown leatherette, has a detachable lid and is supplied with strong fittings and a speaker grille of ample proportions. Considering its fairly large size, it is not exceptionally heavy.

The Symphony Mk. 3 was tested for frequency response and two response curves are shown in Fig. 1, one for the overall response from tape head to loudspeaker and the other from tape head to the external amplifier outlet. The test showed close agreement with the specification given for the Truvox K type amplifier which, when fed into an external power amplifier, is capable of very good quality reproduction.

Hum and noise was comparable with the specification given for K type amplifier, which is minus 45 dB at maximum power output. Slight grid hum was, however, noticeable at maximum setting of the gain control.

The deck showed no tendency to wow and a further test on the amplifier proved that very little inter-modulation distortion and beat note effects are present, a characteristic which many recorders seem to be lacking these days. Erase is clean and noiseless and recordings are clear and brilliant when made from a good microphone or a suitable radio or pick-up source.

I should like to add that the amplifier design is a good one and uses an EF86 low noise valve as head amplifier, with a twin "T" network in negative feedback for CCIR correction from one half of an ECC83 intermediate amplifier. Output power and bias voltages are taken care of by an EL84 which provides up to four watts or audio.

The Symphony Mk. 3 deserves credit for its reproductive qualities, especially when one considers the low price. Quite obviously, much thought went into the design of the instrument. It has full facilities, is of sound construction, and is likely to prove popular with seriously-minded recording enthusiasts.

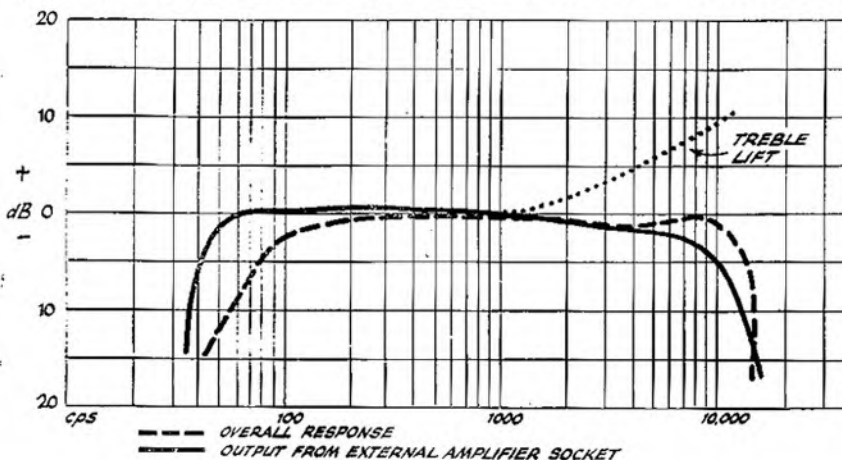

"Symphony" tape recorder frequency response tests  
(reference—1,000 cps) at  $7\frac{1}{2}$  ips.

## V.I.Ps PEOPLE IN THE NEWS



John Wooler      Geoffrey Bizley

The Board of E.M.I. Sales & Service Ltd. has been strengthened by the addition of two new directors. John Wooler, General Manager of the Recording Materials Division of the Company, is now appointed a director and is joined by Geoffrey Bizley, who was seconded from the parent company, E.M.I. Ltd., towards the end of last year to advise on accounting organisation.

These two appointments are linked with the considerable expansion now taking place in the development and production of new magnetic tapes by the Recording Materials Division (Emitape, Emifilm, video tape, etc.) and the entry of the Office Equipment Division (Emidicta, Minifon, etc.) into this field with the introduction of a new range of dictation machines employing tape cassettes.

Mr. Joseph Samuels, who, as a member of the Board of Winston Electronics, Ltd., Shepperton, Middlesex, has been Purchasing Director for several years, has now been appointed Works Director in charge of production.

Mr. Samuels is 49 years old; he was educated at St. Mary's College and the Imperial College of Science.

Before joining Winston Electronics in 1954, he was for several years with Standard Telephone and Cables, and later with Sunvic Controls, of Associated Electrical Industries, Ltd.

He joined the Board of Winston Electronics in 1956.

Hector V. Slade, managing director, has been appointed deputy chairman of Garrard Engineering and Manufacturing Co. Ltd.

### B.B.C. "Sound" Programme

**Questions and Answers:** Peter Walker, John Borwich and I. W. Jarman answer questions sent in by listeners.

**Teaching Tape:** What goes on inside the amplifier. The teacher: I. W. Jarman, the pupil: Angela Jeffreys.

3 p.m. Sunday, April 24, with a repeat at 6.40 p.m. Monday, May 2

## RECORDING MUSIC? — HERE ARE THE PLAYING TIMES

WE have had requests to resume the publication of lists of playing times of well-known music. We are pleased to reintroduce this feature and we shall be obliged if readers will send us information which they have gathered in this field.

It is necessary to remind readers that playing times can vary quite considerably according to the performance and the conductor. Where several timings have been given us for the same item, therefore, we quote the longest. Even so, it is probably a good idea to add a "reserve" of tape of, say, five minutes.

Here are the timings for Beethoven, Rossini and Mozart works. Other composers will be dealt with in later issues.

### BEETHOVEN

*Symphonies:* No. 1, 23 minutes. No. 2, 33 minutes. No. 3, 50 minutes. No. 4, 33 minutes. No. 5, 30 minutes. No. 6,

40 minutes. No. 7, 36 minutes. No. 8, 25 minutes. No. 9, 65 minutes.

*Piano Concertos:* No. 1, 41 minutes. No. 3, 39 minutes. No. 5, 31 minutes.

*Violin Concerto in D,* 38 minutes. *Leonora No. 1,* 11 minutes. *Leonora No. 2,* 16 minutes.

*Coriolan,* 7 minutes.

*Egmont,* 9 minutes.

### ROSSINI

*La Cenerentola,* 9 minutes.

*Overtures:* Italian Girl in Algiers, 9 minutes. The Silken Ladder, 7 minutes.

The Thieving Magpie, 11 minutes. William Tell, 13 minutes. La Cambiale di Matrimonio, 6½ minutes.

### MOZART

*Symphonies:* No. 32, 7½ minutes. No. 33, 17 minutes.

Overture to the Marriage of Figaro, 4½ minutes.

## MAGAZINE DIGEST

In this column we draw attention to items published elsewhere which may be of particular interest to readers.

**Amateur Tape Recording:** "What is a bias oscillator?"

**Amateur Film Maker:** "A System for sound films," by J. G. Assenheim.

**Revue de Son (France):** An illustrated article on dubbing stereophonic tapes.

**Hi-Fi News:** A new approach to stereo reproduction.

**Wireless World:** "Transistor tape recorder amplifiers," by Peter W. Blick. "Further thoughts on Stereophonic Sound Systems," by Dr. D. M. Leakey.

All the above issues are dated April.

## WINSTON ELECTRONICS

An announcement from Winston Electronics Ltd., manufacturers of the *Thoroughbred* recorders, states that the company has been acquired by Dynamics Corporation of America. No change will be made in the management and it is planned to double the company's capacity over the next two years.

### Price Reduced

## TAPE TIME CALCULATOR

The *Tape Recording and Hi-Fi Magazine* accessory, giving playing times for any size reel or length of tape is now available again—and at a reduced price.

Repeated requests for this simple, read-at-a-glance device for any speed from ½ to 15ips, have led us to reprint and orders can now be accepted at the address given below.

Price 2/6d

(3/- including postage)

Order from:

Tape Recording Magazine, 7, Tudor St., London, E.C.4

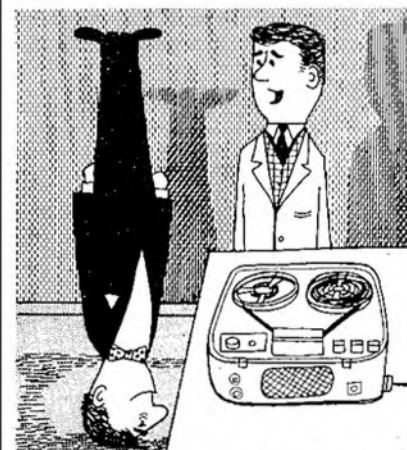

"Okay, I can take a hint, Harry. You want to play your Australian recordings."





# New Products

## ANOTHER NEW FIRM ENTERS TAPE FIELD

*"Emphasis on Workmanship"*

The new  
"Chelsea"

A NEW firm enters the tape recorder market with the "Chelsea," a medium-priced, three-speed mains model selling at 42 guineas, including microphone, direct recording lead and 1,200 feet of tape.

The makers, Beulah Electronics, announce that emphasis has been placed on standard of workmanship and technical design sooner than on a multiplicity of gadgets.

Particular attention has been paid to accessibility for servicing. Although the tape deck, amplifier and power supply can be removed from the cabinet as one chassis, unit construction has been employed. The power supply and amplifier have been constructed on separate screened sub-chassis, with the aim of reducing residual hum level to negligible proportions.

Frequency response is quoted at up to 12,000 cps at  $7\frac{1}{2}$  ips,  $\pm 3$ dB. Three four-pole induction motors are used, with a heavy balance flywheel, and wow and flutter is stated to be better than 0.15 per cent at  $7\frac{1}{2}$  ips.

Speeds are  $7\frac{1}{2}$ ,  $3\frac{3}{4}$  and  $1\frac{1}{2}$  ips. Seven-inch reels can be used. The amplifier provides three watts through an internal speaker, but a socket is provided for an external speaker. A hi-fi jack socket provides a high impedance output source, and is internally connected to a stage prior to the output valve.

There are inputs for radio and microphone, level indicator, digital counter, and pause control.

There is an attractive two-tone cabinet, with wood-grain grey and either blue or red, and gold beading.

Direct TV Replacements Ltd., 138 Lewisham Way, New Cross, London, S.E.14.

### The new tapes

## GEVASONOR FROM BELGIUM

ANOTHER tape newly available in Britain is the Belgian-manufactured Gevasonor, which is available in all the usual sizes and in standard and long-play types.

This firm has paid special attention to spooling and packaging. The design of spool provides for very rapid threading, and a plastic clip is now supplied to prevent loose ends of tape coming adrift.

The tape is put into plastic envelopes before being boxed. Incidentally, the small message spools are supplied in a special, reinforced box which provides space for an address, so that it can be mailed without further attention.

Taking Gevasonor long-play as an example, several tests were made and it was not possible to find any fault with it.

It has a cellulose acetate base and is ideal for recording musical items that may have to be edited. It may be joined, after cutting, by the use of ordinary film cement, with an overlap of only  $\frac{1}{8}$  in.

Although less strong than tape with a Mylar base, Gevasonor should not break under normal use.

Using a good-quality tape recorder with adjustable bias, it allows a frequency range as good as any tape yet produced. It should be noted, however, that Gevasonor needs about 25 per cent more bias than most magnetic tape of other makes.

The new Gevasonor can be instantly recognised by its red matt back, on which it is possible to write—a great aid when editing. The oxide side of the tape is also matt, so the colour enables the user to see quickly which way to thread the tape.

A green leader indicates you are about to use track one; a red trailer signals track two. Leader and trailer are provided with a spouted stop foil for automatic stop or direction-change.

Gevasonor is supplied in two types—Type M, a very strong tape for intensive use, and Type L.R., a thin, long-play tape. Both types are available on spools of 4, 5, 6, 7 and 10 inches. On a 3-in. spool L.R. tape only is available.

## Triumph Tapes will star British talent

Popular music on a new label named Triumph, marketed by Saga Records Ltd., will be aimed at the teenage market. It will seek to encourage new British talent and for the moment they do not intend to introduce American recordings.

First title under the new label is Joe Meek's outer space music fantasy *I hear a New World*. Rod Freeman directs "The Blue Men" on this monaural tape at  $7\frac{1}{2}$  ips.

Disc as well as tape will be available, the tapes selling on a five-inch spool at  $7\frac{1}{2}$  ips. Monaural tapes will be 35s., stereo versions, 55s.

In future the Saga label will be used for classics and light music only.

Saga Records Ltd., 540, Holloway Road, London, N.7.

### MISSING

THE WYNDSOR Recording Co. Ltd. advise that a "Victor" tape recorder, serial number 20334, was stolen from Messrs. N. Reder Ltd., 223/225, Hackney Road, Shoreditch, London, E.3, on Saturday, March 26.



The new Butoba battery-operated MT 4 recorder, which was described fully in our March 9 issue and which will be demonstrated for the first time in this country at the Audio Fair



## YOUR LOCAL DEALER

In this feature you can check your nearest dealer who is a hi-fi specialist giving expert attention to tape equipment.

### LONDON

#### Hi-Fi Consultants and Dealers

STUDIO RECORDING AND  
DUBBING FACILITIES  
Studio A, 40 ft. x 40 ft.

TAPE TO DISC  
professional standards

#### OLYMPIC SOUND STUDIOS

Carton Hall, Carton St., London, W.1  
Tel.: HUN 1635

Agents for SAGA Records and Tapes ★ Dealers in CQ Audio Equipment

### NORTH-WEST

YOUR NORTH-WEST DEALER ENTHUSIASTS

#### SIMON

THE SUPREME RECORDER FOR THE  
CONNOISSEUR. SEND FOR FULL  
ILLUSTRATED SPECIFICATION AND  
TERMS TO SHINNS Ltd.

(20 years Recording and Service experience)

TOWN CENTRE, LEIGH, LANCs.

Branches: "Melody House," Hallgate, Wigan.  
"Melody House," High St. Bangor, N. Wales.  
"Melody House," Culcheth, Warrington.

Free demonstrations within 60 miles but  
NO MAIL ORDER

### MANCHESTER

HIGH FIDELITY DEVELOPMENTS LIMITED  
THE SOUND REPRODUCTION SPECIALISTS

#### for TAPE RECORDERS

FERROGRAPH : TELEFUNKEN : PHILIPS  
HARTING : GRUNDIG : REFLECTOGRAPH  
BRENELL : WYNDSOR : TANDBERG etc.

RADIO TUNERS . LOUDSPEAKER SYSTEMS

#### The HOME MUSIC Shop

8 Deansgate  
MANCHESTER  
(Near Grosvenor  
Hotel)



# News from the Clubs

Edited by

**FRED CHANDLER**

THE National Federation of Tape Recording Clubs have offered to present a prize for the British Amateur Tape Recording Contest.

The prize, in the form of a rectangular wooden plaque, roughly 15in. by 12in., will be awarded to the best entry in the Club Section, and will have a metal border upon which will be space for the engraving of the holder's name.

Secretary Alan Stableford, giving me this news recently, said that he hoped the plaque would be ready in time for the Convention to be held in London on June 11. The final design of the plaque, has still to be decided.

He will have available, however, the introductory cards for use by club members when approaching official Bodies and organisations for recording purposes. These will be given to the Member-Club Secretaries, who will be responsible for seeing that the cards do not go to any "unauthorised" persons or are misused in any way.

Alan Stableford reminds clubs that the Committee will be pleased to visit them on invitation, although Secretaries are requested to give plenty of notice in each case.

The Federation's technical service covering equipment in all branches of sound recording has commenced. Technical information and assistance is available, to member-clubs only, for the cost of a postcard to the Secretary. They are now in the position to give this service, especially where local retailers and engineers are unable to help and the returning of equipment may be costly or time-consuming. Inquiries about particular machines should mention the type, serial number, and date of purchase; if applicable a full description of the fault should be given.

At the March meeting of the London club, Roger Aslin was presented with the McManus Cup, his prize for the winning entry in the club's recent sound competition. The competition, entitled "Friends and neighbours," was the first of a series planned for members. The final judging of the competition was carried out by the Editor of *Tape Recording Magazine*.

After the presentation, members heard a talk and demonstration of editing and splicing.

Eleven machines were operating throughout the evening, including four Fi-Cords, two Vortexions and a home-built model.

A number of visitors attended the meeting, and four decided to join. A dubbing session was scheduled for their latest meeting, April 14. Six machines

were promised for the session, so I should imagine a worthwhile evening was spent sorting out the various tapes.

At the latest meeting of the Ipswich club, three machines were demonstrated by their owners. Miss Diane Jewell introduced the Philips 4-track EL3542, John Cooper presented the Steelman Transistape portable, and the latest EMI model, the TR/52/2/CH, was shown by John Clover.

Members are continuing their rapid "turn-round" of tapes received from other clubs. The latest reply was sent to the Bristol club.

The production of a ten-minute feature tape on their town was started at the March 24 meeting of the Rugby club. Material already collected by members for their individual *Our Town* tapes was heard and excerpts were dubbed for inclusion in the master tape which has been requested by an Australian tape contact. The tape is eventually intended for broadcasting on an Australian radio network.

While some members have been out collecting further material for this tape, others have been active in a variety of ways. At the request of the Teachers' Association, Club President, Mr. Bannister, assisted by Mr. Dawson, recently gave a demonstration of recorders to teachers at the Lawrence Sherriffe School; and Mr. Tilcock has been busy back stage at the Granada Theatre interviewing Jimmy Clitheroe.

Their April 7 meeting was arranged to include a demonstration of the Cosmo-cord accessories.

On March 31, a number of members visited the Coventry club.

The best attended meeting of the Coventry club this year was held on March 17. No less than 35 persons attended, a worthwhile audience for the main event of the evening—a film show.

The film, presented by Mr. M. J. Miles, Public Relations Officer for Coventry Corporation, was in colour and was a synopsis of the Lord Mayor's year of office. Mr. Miles provided a running commentary of the scenes depicted.

After an interval, a second film, of the previous Lord Mayor's tour of duty, was shown. Both these films were made by amateur cine enthusiasts in the Councils' employ and were of first class quality, writes Mr. Penfold.

The recordings being made by Coventry members of events in the city will now probably be used by the Corporation to add sound to the films in their archives. Just another example of the liaison between club and city officials.

A demonstration of the Philips four-track monaural recorder followed the

film show. Ron Longmore presented his recently-acquired machine, but time allowed for only a preliminary examination and the playback of only one tape on the machine.

Members hoped to have a full examination of this model, and others, when R.E.S. (Coventry) Ltd. visited them at their March 31 meeting.

Five new members joined during the evening, increasing total membership to 33. Mr. Hopfinger's publicity campaign, mentioned in our last issue, seems to be having the desired effect. They hope to pass the forty mark very shortly.

Follow-up to the visit paid by members to Warwick and Leamington Club on March 16, is the news of their success in the raffle at the meeting. Ted Ruff and Carl Briggs won, respectively, a three-inch reel of tape and leader tape. Obviously not wanting to be barred from future visits, the Coventry members graciously allowed the 3rd Prize—an empty three-inch reel—to be drawn by a Warwick member.



Coventry Club members record a reply on a Telefunken 85KL to an exile in the U.S.A. Roy Penfold holds the tape received from America

Four days previous to that visit, several members were invited to the Annual Reunion of a Boy Scouts Troop. After watching indoor games and listening to the "Scouts Parliament," they demonstrated Roy Penfold's Ferrograph, Roy Reynold's Philips AG8018, and Howard Freer's home-built recorder.

Mr. Penfold gave a talk on the club's formation and briefly outlined their activities. A tape Henry Hopfinger had received from a Tampa, Florida, contact was then played, followed by their long-standing favourite "Strange to your ears" tape, and a recording of a Boy Scout Band.

When the interlude, as provided by the Coventry members was completed, they were invited to stay and watch the final part of the evening's entertainment—a colour film, from the Jaguar Car Company's library, of the Le Mans 24-hour race.

Eighteen persons were present at the February 10 meeting of the West Middlesex club. A number of those unable to attend had sent along tapes for inclusion in the inter-club tape organised between the clubs in Glasgow, London and West Middlesex, and the evening was spent sorting the entries out. In the event too much material was submitted, and the special group formed for this project set to whittle the entries down into a concise matter. One of the points raised

as a result of this work concerned a sound effects library, and members were asked to collect recordings for this purpose.

Their meeting a fortnight later centred around a demonstration of the Stereophoner. Mr. D. Dumville of Northern Radio Services, the manufacturers, presented the demonstration. The tapes used for the demonstration were made by Mr. Dumville who, writes Secretary H. E. Saunders, "has the courage of his convictions."

A colour film show, with tape commentary was arranged for their April 13 meeting, followed by the sifting of further material for the exchange tape and examination of any sound effects submitted.

Their following meeting, April 27, will see Philip Pratt and David Lloyd explaining how a cathode ray oscilloscope is useful in tape recording.

Fred Gazeley has had to resign as editor of the monthly tape magazine. Thanking him warmly for his strenuous efforts in the past, members agreed that Ken Phipps and the Secretary should share the chore in future.

Members of the Urmston club recently toured the local B.B.C. Studios. They spent an interesting afternoon in the control room, and now look forward to a return visit.

Secretary, T. L. Bullock, 30, Kirkstall Road, Urmston, Lancashire, is keen to welcome new members and asks any interested person to contact him at that address. Meetings are held fortnightly at a private address pending the enrolment of enough members to warrant a club room.

Production of sound effects has become almost a full-time activity of the Grantham club members. At their March 3 meeting the evening was devoted solely to this cause. Among other experiments they produced the sound of falling rain by screwing up a plastic bag and playing back the recording at half-speed.

Avidly following Alan Beeby's series of sound effects, they have been trying out a number of his suggestions. The prolonged bell-tone effect, described in our February 10 issue, was tried and proved highly successful. Mr. Beeby, having read in this column that the members were experimenting in this way, contacted the Secretary and as a result has agreed to set the conditions for an effects competition and help in the final judging.

Recorder demonstrations are also holding their own amongst members. On March 3 Geoffrey Harris exhibited his Wyndor Viscount and dismantled the machine for a thorough examination; and on March 8 Ivan Brown demonstrated a Philips recorder and his home-built loud-speaker cabinet housing a 12-in. speaker and a tweeter.

The second of their monthly special demonstrations was held on March 17 when Mr. Pontzen, Technical Manager of Lustraphone Ltd., presented the range of microphones manufactured by his firm.

R. V. Huddleston's Reflectograph stereo unit was used for the demonstration which included the now familiar demonstration of the noise cancelling model. For this Mr. Pontzen talks quietly into the microphone while members "raise the roof" around him. On play-

back not a sign of extraneous noise is heard.

At their meeting on March 25, a general discussion evening, members made arrangements for a group visit to the Audio Fair on April 24.

The A.G.M. of the West Wales club, the first club formed in Wales, was held on March 17. Gareth Jones was elected to serve another term as Secretary and Tom Evans was elected Chairman. The Treasurer is Mr. J. W. Nelson.

Among points raised in the general discussion was the suggestion that the club should embark on several campaigns to raise funds. Several organisations have approached the Secretary requiring recordings of local functions, and in this light it is thought it may be a good idea to advertise this service and charge accordingly.

Another point was the reduction of the annual subscription. In future, full members will pay one guinea, and associate members (under eighteen) will pay half-a-guinea.

The Hospital Tape Service is to have a further supply of tape, now that the present stock is full. These hour-long, local flavour programmes, mostly in Welsh, are kept since there is a turnover of patients on an almost weekly basis at most of the hospitals covered. This means the same programme can be replayed over a short period.

## FORTHCOMING MEETINGS

**BIRMINGHAM:** Every Monday at the White Horse Cellars.

**BLACKPOOL:** Every Wednesday at 173, Church Street.

**BOURNEMOUTH:** Alternate Tuesdays at the Civil Defence Centre, Holdenhurst Road. (Next: May 3.)

**BRIGHTON:** Every Tuesday at Fairlight School, Pevsey Road.

**CHESTERFIELD:** Every 3rd Monday at the Yellow Lion Inn, Saltergate. (May 2.)

**COVENTRY:** Alternate Thursdays at Rotherham's Social Club. (April 28.)

**CRAWLEY:** 1st and 3rd Mondays in month at Southgate Community Centre.

**EDINBURGH:** 1st Tuesday and 3rd Sunday at 23, Fettes Row, Edinburgh 3.

**GRIMSBY:** Alternate Tuesdays at the RAFA Club, Abbey Drive West, Abbey Road. (March 29.)

**GRANTHAM:** Weekly. 1st week, Wednesday; 2nd, Monday; 3rd, Thursday; 4th, Friday at Grantham Technical College, Avenue Road.

**ILFORD:** Alternate Thursdays at the RAFA Rooms, Cranbrook Road (April 21), and immediately on Fridays at the Pioneer Market Committee Rooms, Ilford Lane. (April 29.)

**IPSWICH:** 1st Saturday at the Art Gallery Committee Rooms, High Street.

**LEEDS:** Every Thursday at the British Legion Club, Albion Street, Leeds 1.

**KEIGHLEY:** Alternate Wednesdays at the South Street Sunday School Rooms (April 20.)

**KETTERING:** Alternate Wednesdays at the Rising Sun, Silver Street. (April 27.)

**LONDON:** 2nd Thursday at the Abbey Community Centre, Marsham Street, S.W.1.

**LUTON:** 2nd and 4th Tuesdays at 17, Dunstable Road.

**MANCHESTER:** Every Saturday, 6 p.m., at 20, Naylor Street, Hulme, Manchester 15.

**NORTHAMPTON:** Every Tuesday at 36, Spring Gardens.

**NOTTINGHAM:** Alternate Thursdays at the Co-operative Educational Centre, Broad Street. (April 28.)

**WEST MIDDLESEX:** 2nd Thursday at the Co-operative Hall, Station Road, Hampton, and 4th Thursday at St. George's Hall, Lancaster Road, Southall Broadway.

**WEST WALES:** 1st and 3rd Thursday at the Club Room, New Street, Aberystwyth.

**WEYMOUTH:** Alternate Wednesdays at the Waverley Hotel, Abbotbury Road. (April 20.)

**WINCHESTER:** Every Friday at The Ship Inn.

**YORK:** Every Thursday at 25, Broadway Grove, York.

Meetings normally start between 7 and 8 p.m.

# SPECIAL OFFER — Half-a-crown to find a ready buyer or a willing seller

**IF YOU HAVE SURPLUS EQUIPMENT YOU WISH TO SELL, OR IF YOU WANT TO BUY ITEMS SECOND-HAND, YOU WILL GET RESULTS BY USING OUR CLASSIFIED COLUMNS. TO PROVE THE POINT, WE ARE OFFERING READERS A SPECIAL RATE UNTIL SEPTEMBER 1st NEXT—2s. 6d. FOR UP TO TWENTY WORDS IF YOU USE THE FORM BELOW**

## Classified advertisements

**Trade, ninepence per word (minimum 10s.); box numbers, one shilling extra. Payment with copy. Copy should be sent to Advertisement Department, "Tape Recording Magazine," 1, Crane Court, Fleet Street, London, E.C.4.**

Balmoral Recorder. Motek K 10 Dec. Complete with Acos Mike and Jack Plug. £25 o.n.o. A. Kemp, "Rhondda," Hullbridge Road, Rayleigh, Essex.

For sale—Brenell Tape Deck, perfect condition, three speeds, £12. Lambe, 24, Belmont Avenue, East Barnet, Herts. BARNET 6469—Evenings.

Philips 3 speed tape recorder. 62 gns. when new, almost five months old. Excellent condition, £55 o.n.o plus carriage. T. W. Rowsell, 10, Howard Road, Wellington, Somerset.

Harting HM8, Stereo, New, Unused. Makers Guarantee. £75. Phone FIN 6001.

**TAPE RECORDERS.** Large selection of used models, most as new with Three Months Guarantee. Part exchanges with Cameras, Binoculars, Radios, etc. Good quality Recording Tape at competitive prices. Cooks Store, 159 & 187, Praed Street, W.2 (both opposite Paddington Station). PAD 6464.

Geloso G.256 Recorder—New condition. Nine months guarantee, with mic., 18 gns. Collaro Studio Deck (cartoned) 13 gns. Telefunken Record Heads—New —3 gns. Box 348.

Telefunken 75 K—15 KB. Perfect condition £45. Elizabethan Avon, as new, complete with microphone and tape, £23. J. Hutchinson, 9, Longridge Ave, Saltdean, Sussex.

Ferrograph 3/AN, very good condition. Reason for disposal: gone stereo. Offers over £50. Box 347.

Portable amplifier, 25 watt, four inputs, Tremolo Goodmans speaker, super model, suitable radio, tape, vocals, guitar, etc. £22. Tel. CRE 7949 for appt.

Wyndor Viscount, as new, £40. Wharfedale PST/8 8 in. FS/AL super unit. £10. Reflectograph 500. All under guarantee, £85. Wanted—Fi-Cord. B. Glanville, 64, Northampton Road, Market Harborough, Leics.

Simon SP2, £45 o.n.o. Ferrograph 4/AH as new, £75. Goodsell Stereo II pre-amp., £20 o.n.o. Power amplifier, £19 o.n.o. Knights, 98, Handford Road, Ipswich, Suffolk.

Ferrograph 3/AN, good condition, demonstrations near Leicester. Owner needs money. Try offer £65 including tape, mic., etc. Box 345.

Telefunken 85KL, still under guarantee, £65. A. R. McCrae, 15, Platt Street, Hadfield, Manchester.

Want to hire battery recorder—July, August—or buy. Box 344.

For sale. Fi-Cord complete, spare batteries, nine months old, £45 o.n.o. D. H. Cohen, 18, Keyes Road, London, N.W.2. GLADstone 4148.

Wanted. Stuzzi Magnette or Butoba MT4 in good working order. Cash waiting for sender of best offer; also good mike. Jones, 66, Merwell Road, Flixton, Manchester.

For Sale. Tandberg Stereo Quadruple Plus Stereo Add-on Unit. Cost £147, six months old. £100 o.n.o. Box 346.

WAL . . . meet us at THE AUDIO FAIR from 21st to 24th April inclusive. Wellington Acoustic Laboratories Ltd., Farnham, Surrey.

Impecunious musician seeks Philips (or other good) three speed Tape Recorder at price within his reach. Phone Sandiacre 3481 (Notts).

**SPECIAL OFFER! SAVE 11 Gns.** Stella-Philips Tape Recorder. Three speeds with moving coil mike. List 63 gns. OUR PRICE 52 gns. or Terms. E. C. Kingsley & Co., 132, Tottenham Court Road (corner Warren Street), London, W.1. EUSon 6500.

One-tenth Deposit—Three Years to Pay! All makes stocked, let us quote you. Simmon of Halifax. Paul Simmon, 35, Northgate, Halifax.

Tape Recorders, players radios, etc. (modern) wanted for cash. Callers or particulars Cooks Store, 159 & 187, Praed Street, W.2 (opposite Paddington Station). Tel.: PAD 6464.

Repairs to all makes! Estimates free! Efficient, reasonably priced servicing by the people who know Tape Recorders. Howard Photographic, 218, High Street, Bromley, Kent. Ravensbourne 4477.

**FRIENDLY FOLK ASSOCIATION,** 87, Terrace, Torquay. Leading International Correspondence Hobby Club since 1943. Now included, facilities for Tapesponding. Details free.

**JOHN HASSELL RECORDINGS.** Tape/Discs. All Speeds, CTR Studio, 21, Nassau Road, London, S.W.13. Riverside 7150.

WAL GAIN transistor pre-amplifier £5. WAL GAIN STEREO Transistor ERASER, cleans a reel in 30 secs. £7 18s. 6d. Ask your dealer for details or send to us for full descriptive leaflets. Wellington Acoustic Laboratories Ltd., Farnham, Surrey (6461 or 4961).

WANTED. Grundig mixer. Must be cheap and in good condition. Marlowe, 117, Virginia Road, Shoreditch, E.2.

WANTED. Ferrograph 3A/N, in excellent condition. Write stating price and possible evenings available for viewing. Must be close to London. Box 350.

Philips EL3527, mint condition, £30, or will exchange for Stuzzi Magnette with cash adjustment. Write Penfold, 48, Holbrook Lane, Coventry.

## CLASSIFIED ADVERT — SPECIAL OFFER

*I enclose postal order for 2s. 6d. Please insert as follows*

**Name**..... **Address** .....

Trade announcements not included. Box number extra

Buddy Holly recordings wanted for copying. Live appearances, not disc. State price. W.B. "Stentorian" Hi-Fi Speaker HF 1012, unfortunately found unsuitable. Bargain, 4 gns. R. E. Goodall, 137, Barnby Gate, Newark, Notts.

Grundig Cub, Boxed, new, unregistered guarantee. Free demonstration or delivery. Greater London. £22 10s. Hayes, 23, Northaw Road, Cuffley, Herts.

Harting HM8 Stereo Recorder, four track, new in carton. Exchange Philips EL3536 Stereo, or sell £82. Box 349.

**GOLDEN TAPES**—Bargain-priced. New plastic tapes for quality recording; Standard (P.V.C.): 600 ft. 5-in. reel—14s. 6d.; 1,200 ft. 7-in.—19s. 9d.; Long Play (Polyester): 900 ft. 5-in.—18s. 6d.; 1,800 ft. 7-in., 33s. 6d. Cash with order—P. & P. 1s. 6d., six or more post free. Guaranteed perfect. Golden Tapes, 11-13, Southampton Row, W.C.1.

Cadenza ribbon mic, as new, £7. o.n.o. Radio components. Communications receiver, Wavemeter, exchange tape accessories. Bargain. Parcels components, 25s. Aldridge, 43, Church St., Chesham, Bucks.

Ferrograph 2A/N. Reslo mic., etc., £55. Write 5, Sudbury Avenue, Wembley, Middx.

Ferrograph 3A/N, perfect condition. Reslo ribbon mic. and transformer, £57 10s. A. W. Marshall, 6, Chalcot Crescent, N.W.1.

Elizabethan Essex Recorder, Simon Cadenza ribbon mic. Cost £80. Perfect condition. £50 bargain. Mr. Funnell, 6, North Street, Alfriston, Sussex.

Sale—Sound Belle Tape Recorder and case. New, cost £29, accept 18 gns. Miss Webb, Terminus 5361 or Flaxman 4735.

Sale—B.S.R.A. Journals, January 1951—February 1960 complete (34 copies). Offers. A. Strange, 29, Marquess Road, Canonbury, London, N.1.

Simon SP4, Cadenza Microphone, cost £110 August 1959. Going Stereo, accept £83. Perfect, as new, demonstrations, details without obligation, genuine bargain. Mr. C. Leyden, 2, Garnett Villas, Otley, Yorkshire. Phone 2228.

For Sale—Vortexion, 2A Deck, £60 or near offer. RIVerside 4936.

Four Track Grundig TK24, latest model. Tape M/C, Mic, cost £68. Unused, £55. F. Riddle, 113, Church Road, Northolt. VIKing 4734.

Fi-Cord wanted. Must be in good condition and complete with charger unit and microphone. D. Graham, 10, St. Johns, Redhill, Surrey. Tel. 3643.

Solid Gold cigarette case, value £35, plus nearly new Elizabethan Avon, offered in exchange for a better quality recorder. Box 352.

Geloso G255, excellent condition, offers? MEA 2430 after 7 p.m. Faith, 28, Brookland Hill, London, N.W.11.

Stereo equipment, as new, Leak Stereo 20, Fane Quartet speakers, Goldring transcription, Dulci tuner, Southdown cabinet. Cost £206, accept £140. Mr. C. Andrews, 164, Beech Hill Lane, Wigan, Lancs.

Harting HM8. Latest 4-track stereo model, as new, perfect. £75 (list £90). J. Hutchinson, 9, Longridge Avenue, Saltdean, Sussex.

**FOREIGN LANGUAGES ON TAPE.** The famous INTERPRET HOLIDAY COURSES (French, Italian, Spanish, German) recorded on your own tapes. 50s. post free, including 100 p. illustrated book and supplement. Additional books available for groups. Details from VISAPHONE CO. LTD., 10, Bayley Street, London, W.C.1.

Wanted—Ferrograph series 4. Write fully to Box 351.

At last, Personal Tape Tuition in arithmetic and English for your children. Interesting and successful. Join now for 11-plus success. S.A.E. for details, 4, Fanshawe Crescent, Hornchurch, Essex. Postal only.

Wanted—Second-hand Leak or similar EM tuner pre-amp amplifier; Axiom 110 and Trebax 5K/20/XL. Terms preferred or cash. Derek Mayhew, 23, Tivoli Road, West Norwood, London, S.E.27.

Harting HM8 Stereo Recorder, four-track, new in carton. Exchange Philips EL3536 stereo or sell £82. Box 349.

.....CUT ALONG DOTTED LINE.....

## ADVERTISEMENT ENQUIRIES SERVICE

**This is a special service for readers of TAPE RECORDING AND HI-FI MAGAZINE. It enables you—without cost—to get fuller information about those products in which you are particularly interested. Fill in one coupon below for each inquiry, writing in your name and address in each case. Then cut out the whole of this half-page, following the dotted line, fold as indicated, and post to us.**

I should like further information about the..... ..... (product) mentioned on page.....of the ..... issue of <i>Tape Recording and Hi-Fi Magazine</i> . ..... NAME ..... ADDRESS..... ..... ..... ..... April 20th, 1960	I should like further information about the..... ..... (product) mentioned on page.....of the ..... issue of <i>Tape Recording and Hi-Fi Magazine</i> . ..... NAME ..... ADDRESS..... ..... ..... ..... April 20th, 1960	I should like further information about the..... ..... (product) mentioned on page.....of the ..... issue of <i>Tape Recording and Hi-Fi Magazine</i> . ..... NAME ..... ADDRESS..... ..... ..... ..... April 20th, 1960
--	--	--

# TAPE TO DISC SERVICES

## Index to Advertisers

**RENDEZVOUS RECORDS**  
(T. H. ADKINS)  
**TAPE TO DISC SERVICE**  
33 — 45 — 78 R.P.M.  
S.A.E. to:  
19 Blackfriars Street, Manchester 3  
Phone: Rusholme 6868

**RAPID**  
**Recording Service**

78's and L.P's from your own tapes.  
Master Discs and Pressings.

Recording Studio  
equipped with Bechstein Grand.

Practising studios  
with or without accompanist.

Mobile Recording Van.  
"Off the Air" Service.

21, Bishops Close, Walthamstow, E.17. COP 3889

When writing to manufacturers for information about new products, please mention that you "saw it in Tape Recording and Hi-Fi Magazine"

**TAPE RECORDER HIRE**  
**TAPE TO DISC 78-LP**  
**RECORDING STUDIO**  
**SALES—EXCHANGES**

**MAGNEGRAPH**

1, Hanway Place, London, W.1.  
s.a.e. for leaflet or  
telephone: LAN 2156

**TAPE TO DISC**  
**RECORDING**

Microgroove LP from 27/6d.  
78 rpm from 11/-  
Also 45 rpm

**48 HOUR SERVICE**

S.A.E. for comprehensive leaflet to:—  
Marsh, "Deroy" Sound Service, Little  
Place, Moss Delph Lane, Aughton, Orms-  
kirk, Lancashire. Tel.: AUG 3102

	page
A.K.G. (Politechna) Ltd. ....	7
Brenell Engineering Co. Ltd. ....	4
Chitnis Electronics. ....	5
Cosmocord Ltd. ....	11
Deroy Sound Service. ....	50
Dickinsons of Pall Mall Ltd. ....	12
Dixon's Electronics. ....	42
E.A.P. (Tape Recorders) Ltd. ....	52
F. A. Hughes & Co. Ltd. ....	Front cover
Gopalco Ltd. ....	42
Gramdeck. ....	8
Gramophone Co. Ltd. ....	2
Grundig (Great Britain) Ltd. ....	3, 5 and 7
Hi-Fi Developments Ltd. ....	46
Howard Photographic. ....	10
Lustraphone Ltd. ....	32
Magnegraph. ....	50
Minnesota, Mining and Manufactur- ing Co. Ltd. ....	38 and 39
Modern Techniques. ....	42
M.S.S. Recording Co. ....	12
Olympic Sound Studios. ....	46
Perth Radios Ltd. ....	51
Psycho-Tape Institute. ....	51
Rapid Recording Services. ....	50
Rendezvous Records. ....	50
Shinns Ltd. ....	46
Simon Equipment Ltd. ....	9
Specto Ltd. ....	13
Tape Recorder Centre Ltd. ....	6
Tape Recorder Service Co. ....	10
Technical Suppliers Ltd. ....	51
The Recorder Co. ....	32
Triumph Records. ....	40
Walter Instruments Ltd. ....	34
Wharfedale Wireless Works Ltd. ...	3

CUT ALONG DOTTED LINE

POSTAGE  
WILL BE  
PAID BY  
PRINT AND  
PRESS  
SERVICES  
LIMITED

THIRD FOLD HERE

TAPE RECORDING & HIFI MAGAZINE,  
ADVERTISEMENT ENQUIRIES,  
7, TUDOR STREET,  
LONDON, E.C.4.

BUSINESS REPLY FOLDER  
Licence No. ND 922

SECOND FOLD HERE

FLAP A

NO POSTAGE  
NECESSARY  
IF POSTED  
IN GREAT  
BRITAIN OR  
NORTHERN  
IRELAND

FLAP B

FIRST FOLD ALONG THIS LINE

**TO OBTAIN DETAILS OF ADVERTISERS** →

Make sure your name and address etc., is clearly shown on the form overleaf.

Cut along the dotted lines.

Fold along lines as indicated and then tuck Flap A into Flap B.

April 20th, 1960

## HI-FI STANDARDS FROM THIS CRYSTAL MICROPHONE

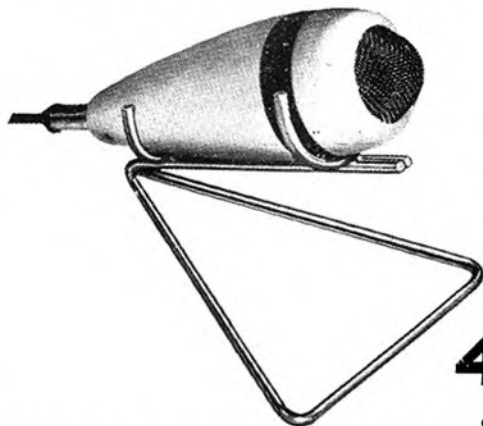

**TSL  
MX3**

**45/-**

COMPLETE

● Frequency response smooth from 50 to 13,000 c/s.

● For all high impedance inputs.

● Complete with stand and noise-free cable.

The TSL Crystal "stick" Microphone has been developed on quite new lines to combine better reproduction with greater robustness and better handling characteristics than those previously experienced with microphones of this type. The result is a first-class instrument worthy of the very finest recorders. It is ideally shaped for the hand or use on its own modern stand. A pair will be found ideal for stereo. From all good stockists. Leaflet on request.

### OTHER TSL MICROPHONES

M.1. High fidelity dynamic, High Low Imp.  
S.2. Stereo dynamic, high or low imp.

### TECHNICAL SUPPLIERS, LTD.,

HUDSON HOUSE, 63 GOLDHAWK ROAD, LONDON, W.12  
Phone:- SHEpherds Bush 2581 & 4794

## PSYCHO-TAPES

*Home Psychology for  
Tape Recorder Owners*

PERSONALISED tapes recorded individually for each patient by well-known Psychotherapist for:—

**NERVOUS FEARS, STAMMERING,  
INFERIORITY, AND ALL PERSONAL  
PSYCHOLOGICAL PROBLEMS**

Also SPECIAL TAPES on:—

**DEVELOPING A POSITIVE PER-  
SONALITY, SELF-HYPNOSIS, MIND  
MANAGEMENT, HOW TO OVER-  
COME INSOMNIA, ETC.**

Please post Coupon NOW for full details

Please send free details of PSYCHO-TAPES

Name (Mr. Mrs. Miss).....  
(Block letters please)

Address.....

To THE PSYCHO-TAPE INSTITUTE (Dept. THI)  
27, YORK ROAD, ILFORD, Essex

The new **PERTH**

# CLARISSA

tape recorders

Elegant carrying case with olive green spanish hide finish, gilt fittings and a cream plastic front. Easy portability. Highest quality components. Three speeds ( $7\frac{1}{2}$ ,  $3\frac{1}{2}$  and  $1\frac{1}{2}$  inches per second). Maximum playing time of four hours. Tape spools up to 7" diameter. Wow and flutter better than 0.15 per cent at  $3\frac{1}{2}$  ips. Full mixing and superimposing. Unit construction gives easy accessibility and servicing. Separate compensated inputs for microphone, gram/radio. Extension speaker socket with automatic muting of internal speaker. Dimension:  $18'' \times 13'' \times 7''$ .

### CLARISSA MK 1 price 42 gns.

Frequency response up to 10 kcs. Magic-eye. Full-range tone control. Large high-flux speaker giving 3 watts undistorted output. Complete with crystal microphone and 1,200 feet recording tape. Weight 23 lb.

### CLARISSA Twin de luxe MK 2 price 56 gns.

Frequency response virtually straight line from 40-12,000 cycles  $\pm$  3dB. True aural monitoring through separate built-in amplifier channel gives studio grade recording under all conditions. Independent bass and treble controls. Special "grain-orientated" transformer and Mu-metal screening for maximum hum-level suppression. Large bass speaker unit with matched Tweeter unit ensures finest quality output. 4 watts. Complete with dynamic moving coil microphone and 1,200 feet recording tape. Weight 26 lb.

made exclusively by

# perth



EASY TERMS AT YOUR DEALERS

Send for illustrated folder to: **PERTH RADIOS LTD., MARTEN HOUSE, 39-47 EAST ROAD, LONDON, N.1** Clerkenwell 2413-4

# EVERYONE'S GOING ELIZABETHAN

## GOING FOR THE NEW MAJOR!

**New model with performance standards not previously available in any portable tape recorder**

Without exaggeration, this superlative machine offers a standard of performance and a range of facilities only found previously in highest grade professional equipment. Specially fitted 3 micron gap recording head gives phenomenal frequency response and the 6 watts push-pull output ensures sound reproduction of a uniquely high order.

**MAJOR 65** GNS. *Microphone optional extra*



**Go Elizabethan  
at the Audio Fair  
Stand 18  
Dem. Room 348**

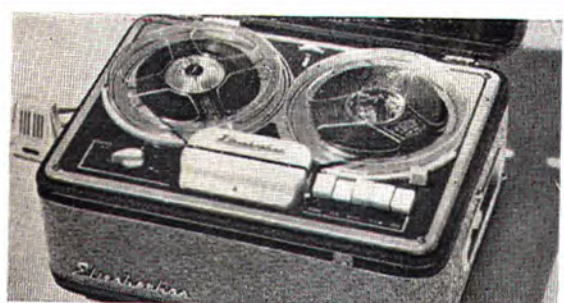

## GOING FOR THE PRINCESS!

Going for tremendous performance . . . for terrific value . . . and getting both. The Princess gives a performance well above its price bracket. And judging from sales, everyone's found that out!

**PRINCESS 39** GNS.  
*complete*



## GOING FOR THE AVON!

The demand is fantastic and not surprising. This is today's most astonishing tape recorder value. A first-class machine with excellent recording quality and sound reproduction. With simple controls and splendid styling. A country-wide best-seller.

**AVON 27** GNS.  
*complete*

**ELIZABETHAN  
TAPE RECORDERS**

Elizabethan (Tape Recorders) Ltd., Romford, Essex. Telephone: Romford 62366/7